

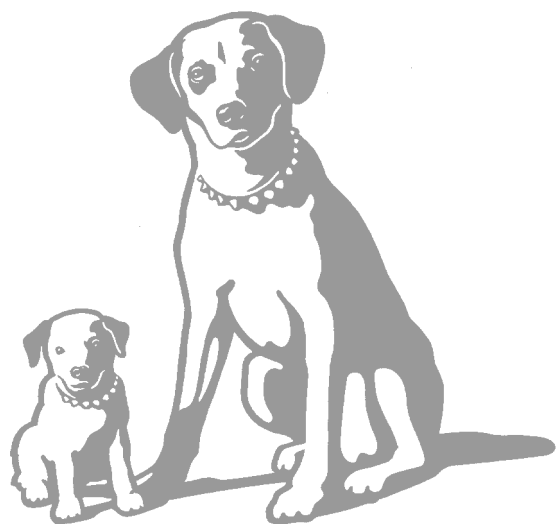

USER'S GUIDE



TV/VCR COMBINATION

TRENT

Important Information



CAUTION

RISK OF ELECTRIC SHOCK
DO NOT OPEN



TO REDUCE THE RISK OF ELECTRIC SHOCK, DO NOT REMOVE COVER (OR BACK). NO USER SERVICEABLE PARTS INSIDE. REFER SERVICING TO QUALIFIED SERVICE PERSONNEL.



This symbol indicates "dangerous voltage" inside the product that presents a risk of electric shock or personal injury.



This symbol indicates important instructions accompanying the product.

WARNING

To reduce the risk of fire or shock hazard, do not expose this product to rain or moisture.

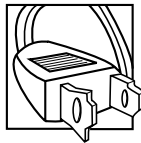

CAUTION: To prevent electric shock, match wide blade of plug to wide slot, fully insert.

ATTENTION: Pour éviter les chocs électriques, introduire la lame la plus large de la fiche dans la borne correspondante de la prise et pousser jusqu'au fond.

Cautions

FCC regulations state that unauthorized changes or modifications to this equipment may void the user's authority to operate it.

Refer to the identification/rating label on the back of the product for the proper operating voltage.

CAUTION: If fixed (non-moving) images are left on the screen for long periods, they may be permanently imprinted on the screen. Such images include network logos, phone numbers, and video games. Extended viewing of channels displaying these images should be avoided.

Note to Cable TV Installer

This reminder is provided to call your attention to Article 820-40 of the National Electrical Code (Section 54 of the Canadian Electrical Code, Part 1) which provides guidelines for proper grounding and, in particular, specifies that the cable ground shall be connected to the grounding system of the building as close to the point of cable entry as practical.

Product Registration

Please fill out the product registration card and return it immediately. Returning the card allows us to contact you if needed.

Keep your sales receipt to obtain warranty parts and service and for proof of purchase. Attach it here and record the serial and model numbers in case you need them. The numbers are located on the back of the TV/VCR combination.

Model No. _____

Serial No. _____

Purchase Date: _____

Dealer/Address/Phone: _____

Table of Contents

Important Information

Warning	i
Cautions	i
Note to Cable TV Installer	i
Product Registration	i

Setting Up the TV/VCR

Startup

Unpack your TV/VCR and Remote Control	2
Insert Batteries in Remote	2
Place Your TV/VCR on a Stable Surface	3
Connect Antenna or Cable-TV System	3
Plug in the TV/VCR	3
Turn On the TV/VCR	3
Select the Language (Escoja un Idioma/Choisissez une langue)	3
Put Channels into Memory (Auto Channel Search)	4
Set the Signal Type (optional)	4
Add or Remove Channels from TV/VCR's Memory	4
Set the Time and Date (Clock)	5
Select a Channel and Adjust the Volume	5

Using the Remote Control

Buttons	6-7
---------------	-----

TV/VCR Features

Using the TV/VCR Features

On-Screen Displays	8
Adjust the Video	8
Closed Captioning	9
Commercial Skip	9
Sleep Timer	10
Wake-Up Timer	10
Front Panel Block	10
Parental Controls and V-Chip	11
Setting TV Rating Limits	12
Setting Movie Rating Limits	14
Blocking Unrated Programs	15
Lock/Unlock Parental Controls	15

Playing a Tape

Operating Instructions To Play a Tape	16
---	----

Using the Playback Features

Pause	17
Frame Advance	17
Picture Search	17
Automatic Tracking	18
Manual Tracking	18
Time Counter	18
Commercial Scan	18
Auto Play Feature	19
Auto Repeat Feature	19
Index Search	20
Zero Search	21
Blank Search	21

Recording a Program

Recording Features

Recording Speeds	22
Recording Pause	22
Automatic Head Cleaner	22

Types of Recordings

Basic Recording	23
Express Recording	24
Timer Recording	
Setting a Timer Recording	25
Checking or Clearing Timer Recordings	26
Stopping a Timer Recording	26
Copying and Editing Tapes	27

Location of Controls

Front Panel	28
Back Panel	29

Hooking Up the TV/VCR

Choosing a Hookup	29
Connect Antenna or Cable System Without a Cable Box	30
Connect a Cable System With Cable Box	31
Connect VCR or Camcorder for Copying Tapes	32

References

Trouble Checks	33
Cleaning the TV/VCR	35
Limited Warranty	36
Index	37

Startup

1. Unpack the TV/VCR and remote control

Contact your dealer if your remote control is missing.



2. Insert batteries in remote

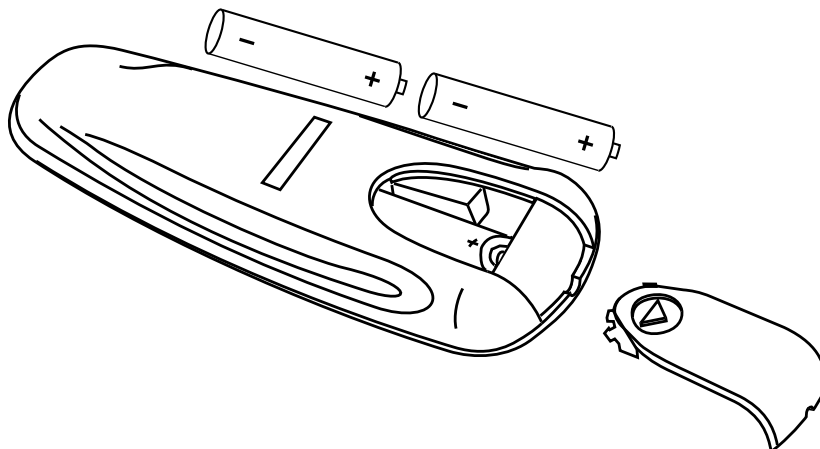

Startup

3. Place your TV/VCR on a stable surface

CAUTION: To reduce the risk of personal injury or damage to the TV/VCR, take care in selecting a surface or stand on which to place your product and when moving or carrying it. Use a stable surface or a strong steady stand and a location where the TV/VCR cannot be tipped over or easily pulled off, particularly by children. Do not attempt to carry or move this product with one hand. Grasp the TV/VCR with both hands with the TV front against your body to prevent it from slipping out of your grasp.

4. Connect antenna or cable-TV system

Connect a home antenna or a cable-TV system. *Details on pages 29-32.*

5. Plug in the TV/VCR

Plug the power cord into the wall outlet, matching the wide blade of the plug with the wide slot in the outlet. Be sure to insert the plug completely.

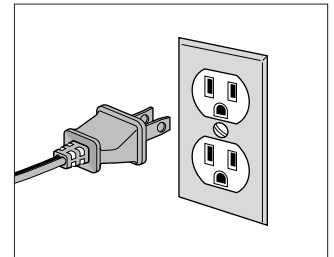

6. Turn on the TV/VCR

Press POWER on the front of the TV/VCR or press TV or VCR on the remote. The indicator in the POWER button on the front of the TV/VCR will light when the TV/VCR is on.

7. Select the language.

(Escoja un idioma./Choisissez une langue.)

This feature lets you select English, Spanish, or French as the language for your on-screen displays.

- A. Press MENU on the remote to display the TV/VCR MAIN MENU.
- B. Press 1 to display the SCREEN menu.
- C. Press 3 to toggle the menu language between English, Spanish and French. The default menu language when you first turn on the TV/VCR is English.

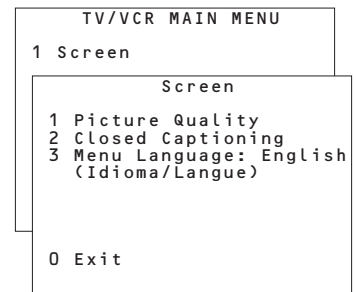

Startup

8. Put Channels into Memory (Auto Channel Search)

- A. Press MENU on the remote to display the TV/VCR MAIN MENU.
- B. Press 5 to display the SETUP menu.
- C. Press 1 to start AUTO CHANNEL SEARCH.
- D. Allow the TV/VCR to search for all channels. Pressing any buttons during Auto Channel Search will stop the search and only some channels will be in the TV/VCR's memory. When the search is finished the TV/VCR will automatically tune to the first channel in the channel memory list.

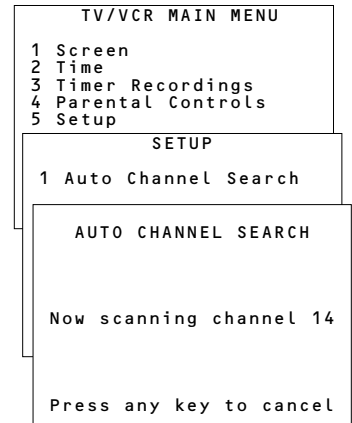

9. Set the Signal Type (optional)

The TV/VCR automatically selects the signal type (cable or antenna) when you run the Auto Channel Search in step 8. If you want to change the signal type, follow the directions below.

- A. Press MENU on the remote to display the TV/VCR MAIN MENU.
- B. Press 5 to display the SETUP menu.
- C. Press 5 to toggle the Signal Type between ANTENNA and CABLE.
 - After changing the signal type, you may need to re-enter the channel number you are trying to receive.
 - After changing the signal type, you may need to Auto Channel Search again.

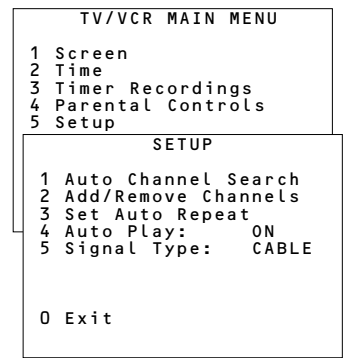

10. Add or remove channels from the TV/VCR's memory

You may want to add or remove channels if some of them are not active, have weak signals, or you do not want them in your channel memory. A channel that has been removed can still be selected by pressing the remote control's number buttons.

- A. Press MENU on the remote to display the TV/VCR MAIN MENU.
- B. Press 5 to display the SETUP menu.
- C. Press 2 to display the ADD/REMOVE CHANNELS screen.
- D. Follow the directions on the screen to add or remove a channel.
- E. Add or remove more channels by entering the channel number or pressing CHAN up or down.

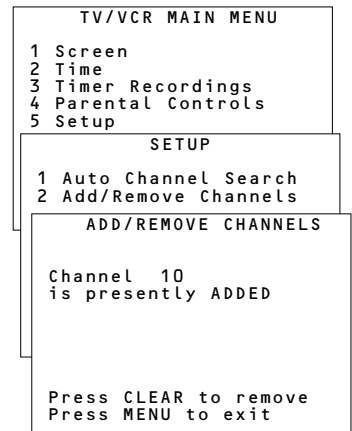

Startup

11. Set the Time and Date (Clock)

To set the clock:

- A. Press MENU on the remote to display the TV/VCR MAIN MENU.
- B. Press 2 to display the TIME menu.
- C. Press 1 to display the SET TIME and DATE screen.
- D. Use the number buttons on the remote to enter the time.
 - Press 0 before 1; 0 is added automatically before all other numbers. Press 1 for AM or 2 for PM. Example: For a time of 1:07 PM, press 0, then 1, then 0, then 7, then 2.
- E. Use the number buttons on the remote to enter the date.
 - The day of the week will automatically appear after you enter the year.
 - Press CLEAR on the remote at any time to change incorrect entries.
- F. Press MENU on the remote to start the clock.
- G. To exit and return to TV viewing, follow the on-screen instructions.
- H. To display the time and date, press DISPLAY on the remote.

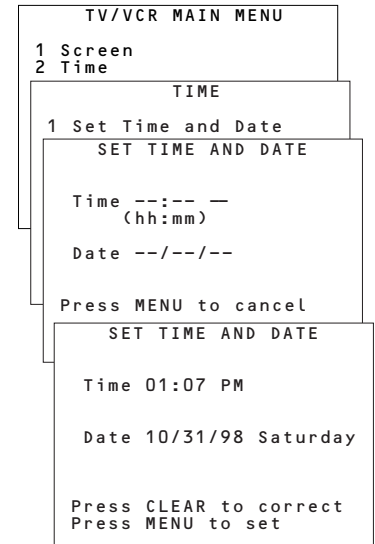

12. Select a channel and adjust the volume

- A. Press CHANNEL up or down or press the number buttons on the remote to select a channel.

Example: For channel 2, press 0 then 2. The channel number is displayed on the screen.

For cable channels over 99, press and hold 1 until 1-- appears. Then enter the next two numbers. Example: For channel 102, press and hold 1. When 1-- appears, press 0, then press 2.
- B. Press VOL left or right to adjust the volume. The volume display appears on the screen.

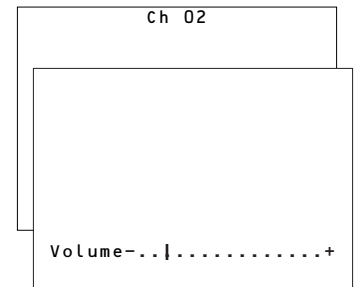

Buttons

This remote has a *Light*  feature that lets you use the remote in a dimly lit or dark room. The *Light* button glows in the dark. Pressing this button lights some of the most commonly used remote buttons. The buttons remain lit as long as any button is pressed within approximately four seconds of the last button pressed. The light times out if no buttons are pressed, which conserves the life of your batteries. If the light times out, simply press the *Light* button to turn it on again.



CHAN ^ and v (Channel up and down)

Selects next higher or lower channel in channel memory.

CLEAR

Removes all menus from the screen.

Allows you to change menu entries or clear a timer recording.

Resets time counter to 0:00:00 when it is displayed.

DISPLAY

Displays TV/VCR's current status.

Displays time counter when a tape is inserted.

Removes displays.

F. ADV (Frame Advance)

Fast forwards the tape through a commercial when a tape is playing.

Advances the tape one video frame at a time when the tape is in PAUSE mode.

FF (Fast Forward)

Fast forwards the tape when the TV/VCR is stopped.

Searches the picture in forward motion during playback.

MENU

Displays the TV/VCR MAIN MENU.

Advances to next program during program review.

MUTE

Reduces volume to a minimum level.

Buttons

Numbers (0 through 9)

Select a channel up to 99 by pressing two numbers.

Select a cable channel over 99 by pressing and holding 1 until 1- - appears on the screen. Then press the other two numbers.

OFF

Turns the TV/VCR off.

PAUSE

Pauses the tape during playback.

Pauses the tape during recording to prevent recording of unwanted scenes.

PLAY

Plays a tape.

PREV (Previous channel)

Switches between the last two channels selected.

Select one channel and then select the other using the number buttons. Press PREV to switch between the two channels.

REC (Record)

Starts TV/VCR recording.
Used for express recording.

RESET

Resets video functions to factory settings.
Used to reset time for wake-up timer and alarm.

REW (Rewind)

Rewinds the tape when the TV/VCR is stopped.
Searches the picture in reverse during playback.

SKIP/SEARCH

Operates Commercial Skip during TV viewing. (This only works when there is no tape in the TV/VCR.)

Displays INDEX, ZERO, and BLANK search screens when tape is inserted in the TV/VCR.

Operates Commercial Scan by advancing tape 60 seconds during playback.

SLEEP

Sets TV/VCR to automatically turn off in 30, 60, 90, or 120 minutes. *See page 10.*

SPEED (Tape Speed)

Selects a recording speed (SLP, SP, or LP).

STOP

Stops functions such as record, play, rewind, fast forward, and pause.

TRACK + and - (Tracking up and down)

Lets you manually adjust tracking to reduce the streaks that may appear in the picture during playback.

TV

Turns on the TV/VCR.

VCR

Turns on the TV/VCR.

VOL < and > (Volume up and down)

Raises and lowers sound.

Using the TV/VCR Features

On-Screen Displays

When you change channels, adjust volume, or use a VCR feature, on-screen displays appear to let you know the status of the TV/VCR.

To Call Up On-Screen Displays

1. Press DISPLAY to display the function, time counter, date, time, and tape speed.
If you do not press DISPLAY again, these displays will time out and disappear.
2. Press DISPLAY again:
 - **No tape in TV/VCR:** Displays are removed.
 - **Tape in TV/VCR:** Time counter remains on screen, and will not time out. Press DISPLAY again to remove the time counter.

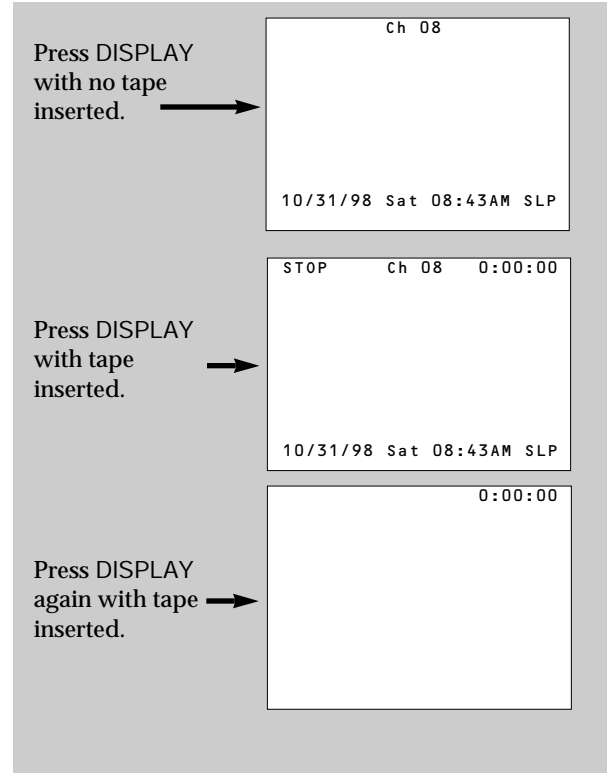

Adjust the Video

Use the SCREEN menu to adjust the picture for your personal preference. The TV/VCR will remember the settings you select.

To Adjust Video

1. Press MENU on the remote to display the TV/VCR MAIN MENU.
2. Press 1 to display the SCREEN menu.
3. Press 1 to display the PICTURE QUALITY menu.
4. Press CHAN up or down to select the function you want to adjust.
 - Select Color to adjust color intensity.
 - Select Tint to adjust for natural fleshtones.
 - Select Contr (contrast) to adjust picture contrast.
 - Select Brite (brightness) to adjust picture brightness.
 - Select Sharp (sharpness) to adjust picture sharpness.
5. Press VOL < or > to adjust the function selected.

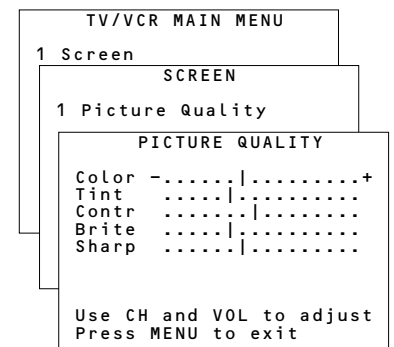

To Return Video to the Factory Settings

Press RESET to reset the video to the levels set at the factory.

The message "All picture controls have been reset to factory defaults" will appear.

Using the TV/VCR Features

Closed Captioning

The closed captioning feature displays the audio portion of a program as text on the TV screen. This is useful to hearing impaired or anyone who wants to watch a program without sound.

There are four types of closed captions: Caption 1, Caption 2, Text 1 and Text 2. Caption 1 displays the full translation of the primary language in your area. Caption 2 may be used as a second source for secondary languages. Text 1 and Text 2 display on-screen boxes containing the text of general information not necessarily related to the program being watched.

Closed captioning is not available on all channels. Check your TV program listings for CC (closed caption) broadcasts.

To View Closed Captions

1. Press MENU on the remote to display TV/VCR MAIN MENU.
2. Press 1 to display the SCREEN menu.
3. Press 2 to display the CLOSED CAPTIONING menu.
4. Press 1 to change the Display.
 - There are three choices: OFF, ON, and ON WHEN MUTED.
 - Each time you press 1 the Display will change on the Closed Captioning menu screen.
5. Press 2 to select the Mode.
 - There are four choices: Caption 1, Caption 2, Text 1, and Text 2.
 - Each time you press 2 the Mode will change on the Closed Captioning menu screen.

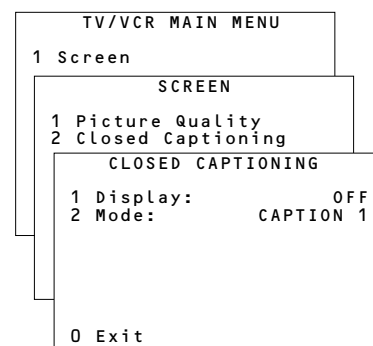

Commercial Skip

As its name suggests, Commercial Skip allows you to bypass commercials during normal TV viewing. When a commercial comes on, you can activate the Commercial Skip timer to run from 30 seconds to 4 minutes. While the timer is counting down, you are free to watch other channels. After the timer runs out, the TV/VCR automatically changes back to your original channel. Use the following steps to program the Commercial Skip timer:

1. On your remote, press SKIP/SEARCH. An on-screen timer appears.
2. Press SKIP/SEARCH repeatedly to set the timer as desired. The time increases by 30 seconds each time SKIP/SEARCH is pressed. Skip countdown starts automatically if you haven't pressed SKIP/SEARCH for two seconds.
3. To cancel Commercial Skip, keep pressing SKIP/SEARCH until the SKIP display disappears from the screen, or press CLEAR. Your TV/VCR will stay tuned to the channel it is on and will not change back to your original channel.

Commercial Skip works only when there is no tape in the TV/VCR.



Using the TV/VCR Features

Sleep Timer

The sleep timer automatically turns the TV/VCR off after 30, 60, 90, or 120 minutes.

1. Press SLEEP on the remote to select 30, 60, 90 or 120 minutes.
2. To cancel the sleep timer, press SLEEP until the timer disappears.

You can also access the sleep timer through the menu system.

1. Press MENU on the remote to display the TV/VCR MAIN MENU.
2. Press 2 to display the TIME menu.
3. Press 2 to display the SLEEP TIMER screen.
4. Press CHAN up or down to select 30, 60, 90, or 120 minutes.
5. Press MENU three times to exit.

While watching a program, press DISPLAY to check the amount of time remaining before the TV turns off.

6. To cancel the sleep timer, first display the SLEEP TIMER menu by repeating steps 1-4 above. Then, repeatedly press CHAN up or down until 0:00 is displayed on the screen.

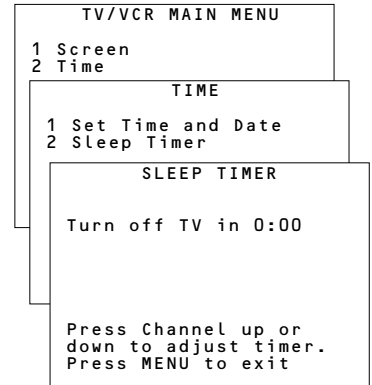
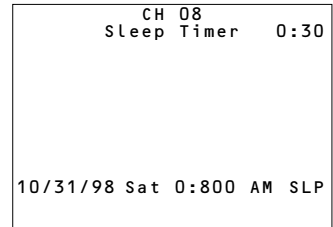

Wake-Up Timer

The timer turns the TV/VCR on at a desired time. You can set it to wake you up in the morning or remind you that a favorite program is about to start.

1. Press MENU on the remote to display the TV/VCR MAIN MENU.
2. Press 2 to display the TIME menu.
3. Press 3 to display the WAKE-UP TIMER menu.
4. Use the number buttons to enter the channel number and time.
 - After you enter the time, press 1 for AM or 2 for PM. Example: For a time of 5:07PM, press 5, then 0, then 7, then 2.
 - Press CLEAR to correct an entry or RESET to clear the timer.
5. Press MENU to set the timer.
 - The wake-up timer will turn on the TV/VCR every day. The WAKE-UP indicator light on the front panel is illuminated when the wake-up timer is set.
 - Once the TV/VCR is turned on by the wake-up timer, the unit automatically turns off after 60 minutes if no buttons are pressed.

Note: When the wake-up timer turns on the TV/VCR, the volume level does not change from when the TV/VCR was last turned off.

6. To cancel the wake-up timer, first display the WAKE-UP TIMER menu by repeating steps 1-3 above. Then, press RESET to cancel the timer, and press MENU to exit. The timer is also canceled if MENU is pressed before step 4 is completed.

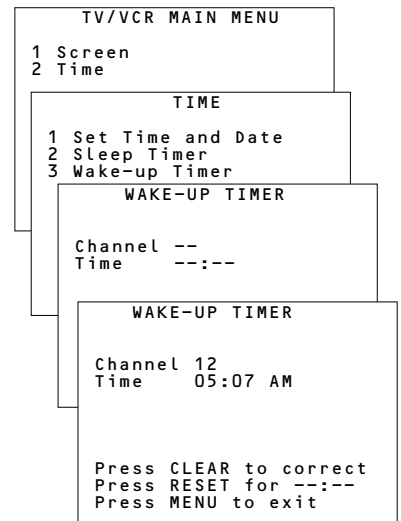

Front Panel Block

Selecting this option lets you block (disable) or unblock (enable) the TV's front panel buttons. Any timer recordings will still record (provided there is a tape in the VCR). Front Panel Block can keep children from watching TV or playing with the TV buttons when a parent is not present.

1. With the TV/VCR on, press and hold the POWER button on the remote for approximately 6 seconds. The indicator in the Power button flashes.

The indicator in the Power button flashes if the STOP/EJECT or POWER buttons on the front panel are pushed but nothing will happen.

To turn off the Front Panel Block, press and hold the POWER button for 6 seconds.

Using the TV/VCR Features

Parental Controls and V-Chip

The Parental Controls menu allows you to program your TV/VCR so that children cannot see certain programs.

The first three choices in the Parental Controls menu involve a feature inside your TV/VCR called V-Chip which allows you to “block” TV programs and movies based on violence, sex, or other content you may believe children should not view. In other words, it lets you program your TV so it will not display certain programs. Once you block programs, you or other adults are not limited to only parent-approved programs; you can “unblock” programs by entering a password.

The V-Chip inside your TV/VCR comes turned “off,” so if you choose not to implement it, you can just ignore it.

When turned “on,” the V-Chip reads a code that most broadcasters send with programs. That code tells the V-Chip the program’s age-based rating (TV-MA, TV-14, etc.) and content themes (Violence (V), Adult Language (L), etc.). If you have blocked the rating and/or content themes that the program contains, you will receive the message, “**This channel is not approved for viewing,**” when you turn to that particular channel. Broadcasters are not required to provide content themes, so programs received with no content themes will only be blocked if you block their age-based rating. You can also block out programs that have not been given a rating, and programs that are considered “unrated” because no code has been sent by the broadcaster.

The age-based ratings and content themes you can block are listed in the table below.

Age-Based Rating	Description and Content Themes for Age-Based Ratings
TV-MA	Mature Audience Only. This program is specifically designed to be viewed by adults and may be unsuitable for children under 17. It contains one or more of the following content themes: graphic violence (V), explicit sexual activity (S), or crude indecent language (L).
TV-14	Parents Strongly Cautioned. This program contains some material that many parents would find unsuitable for children under 14. Parents are strongly urged to exercise greater care in monitoring this program and are cautioned against letting children under the age of 14 watch unattended. This program contains one or more of the following content themes: intense violence (V), intense sexual situations (S), strong coarse language (L), or intensely suggestive dialogue (D).
TV-PG	Parental Guidance Suggested. This program contains material that parents may find unsuitable for younger children. Many parents may want to watch it with their younger children. The program contains one or more of the following content themes: moderate violence (V), some sexual situations (S), infrequent coarse language (L), or some suggestive dialogue (D).
TV-G	General Audience. Most parents would find this program suitable for all ages. It contains little or no violence (V), no strong language (L) and little or no sexual dialogue (D) or situations (S).
TV-Y7	Directed to Children 7 years and older. This program is designed for children ages 7 and above. It may be more appropriate for children who have acquired the developmental skills needed to distinguish between make-believe and reality. Themes and elements in this program may include mild fantasy violence (FV) or comedic violence, or may frighten children under the age of 7.
TV-Y	All Children. This program is designed to be appropriate for all children. The themes and elements in this program are designed for a young audience, including children from ages 2-6. This program is not expected to frighten younger children.

Using the TV/VCR Features

Setting TV Rating Limits

1. Press MENU on the remote to display the TV/VCR MAIN MENU.
2. Press 4 to display PARENTAL CONTROLS.
3. Press 1 to display the V-CHIP TV RATING LIMIT screen.
4. Use the number buttons 1-7 to change the status of a TV program rating. **Remember: Once you have set your limits, you must lock your system in order to activate blocking.**

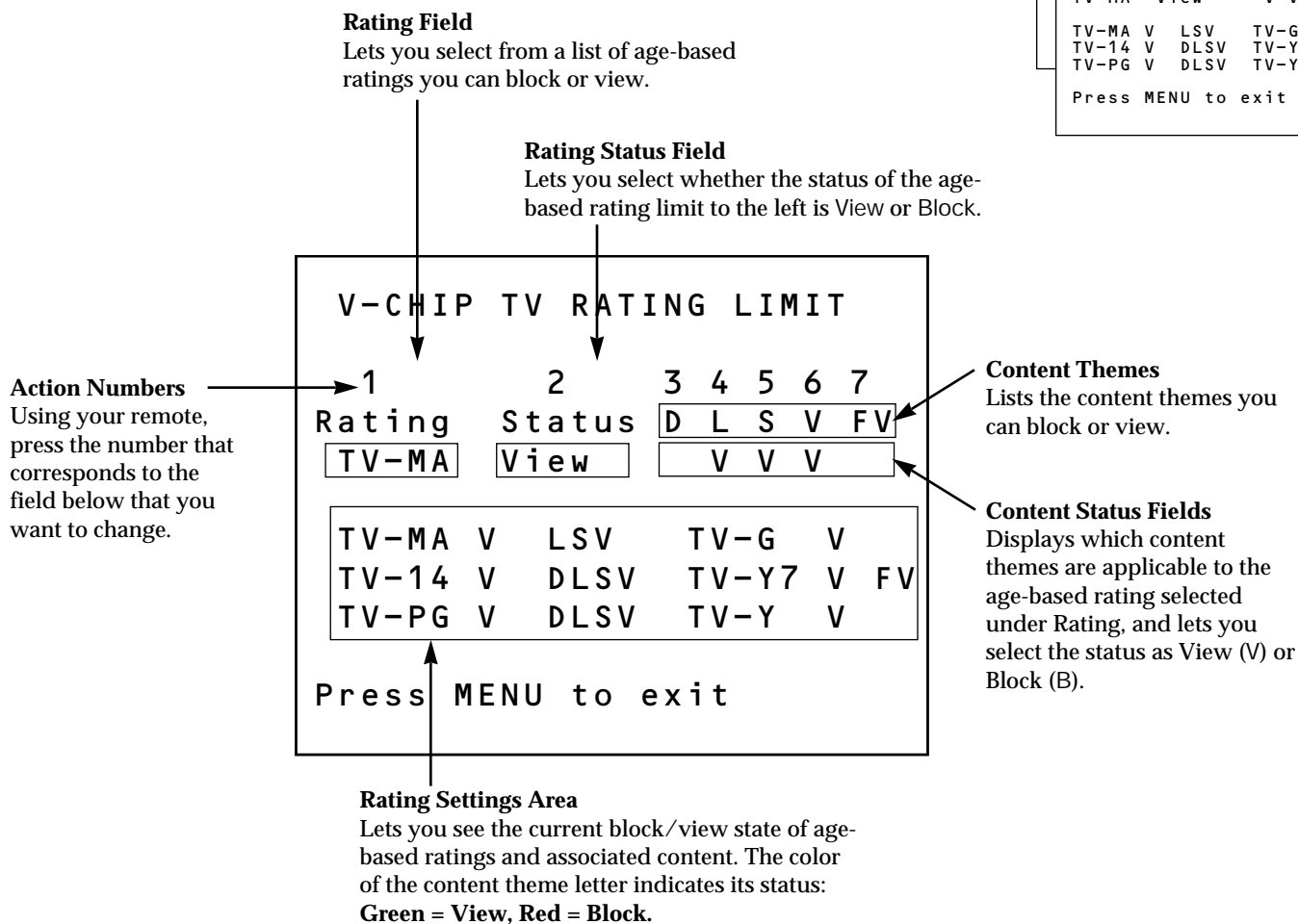
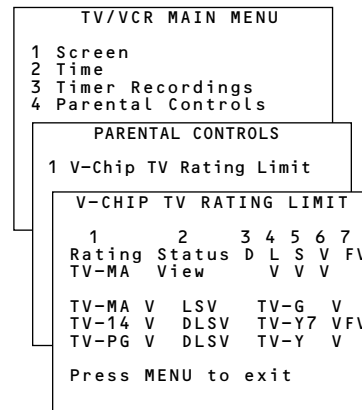

To Block Age-Based Ratings

You can automatically block all program ratings above a specified age-based rating level. For example, if you only want your child to watch programs that have a TV-G rating and lower (in other words, you want the child to watch TV-G, TV-Y7, and TV-Y), then you need to block out other programming with higher ratings.

To block programs with higher ratings:

1. Determine the lowest level rating you do not want the child to watch.
2. Continuously press 1 on the remote to scroll through the age-based ratings. Stop pressing 1 when the lowest rating you do not want the child to watch appears. (In the example, you would press 1 until TV-PG appeared on screen, since the highest rating you want the child to watch is TV-G).

Using the TV/VCR Features

3. Press 2 to change the rating status from View (V) to Block (B). The status for this rating and all higher ratings automatically changes to Block (B) (indicated by the rating limits in the rating status area turning red). Note that all associated content is also automatically blocked.
4. Press MENU to exit and return to the PARENTAL CONTROLS menu.

V-CHIP TV RATING LIMIT										
1	2	3	4	5	6	7				
Rating	Status	D	L	S	V	FV				
TV-PG	Block	B	B	B	B	B				
TV-MA	B	LSV	TV-G	V						
TV-14	B	DLSV	TV-Y7	VFV						
TV-PG	B	DLSV	TV-Y	V						

Press MENU to exit

Changing the TV-PG rating status from View (V) to Block (B) causes the higher ratings and content to block out as well.

Viewing Age-Based Ratings

After you block age-based ratings, you have the option of going back and changing some of the content ratings back to View (V).

1. Determine the rating you want to view that is currently blocked.
2. Press 1 to scroll to the rating, such as TV-14, whose status is Block.
3. Press 2 to change the status to View. Your child would then be able to watch all programs with a TV-14, TV-G, TV-Y7, and TV-Y rating

Note that TV-14's content status fields at the bottom of the screen automatically change to a view state, indicated by green letters. These are the only fields that automatically change back to green when you complete this process.

V-CHIP TV RATING LIMIT										
1	2	3	4	5	6	7				
Rating	Status	D	L	S	V	FV				
TV-14	View	V	V	V	V	V				
TV-MA	B	LSV	TV-G	V						
TV-14	V	DLSV	TV-Y7	VFV						
TV-PG	B	DLSV	TV-Y	V						

Press MENU to exit

Viewing Age-Based Ratings: Press 2 to change the status back to View.

Blocking Specific Content Themes

You can block programs based on their content. (Content is represented by the D, L, S, V, and FV on your screen. See page 11 for details.) When you block a content theme for a particular rating, you automatically block that content theme for higher rated programs as well.

For example, if you do not want your child to watch programs that have adult language (L) rated TV-PG or higher, then you would also block out all programming TV-PG and above containing adult language.

To block program content:

1. Determine the lowest level age-based content you do not want the child to watch.
2. Press 1 until the lowest age-based rating whose content theme you do not want the child to watch appears on screen.
3. To change the content theme to Block (B), press the number on the remote that corresponds with the content theme you want to block:
 - Sexually explicit dialogue (D) = 3
 - Violence (V) = 6
 - Adult language (L) = 4
 - Fantasy violence (FV) = 7
 - Sexual situations (S) = 5
4. After you press the number, the V for the content theme should change to a B in the content status field. In the ratings settings area, all higher ratings' content theme status will automatically change to Block indicated by the letters turning red.
5. Press MENU to return to the PARENTAL CONTROLS menu.
 - Press RESET to return all rating limits to VIEW.

V-CHIP TV RATING LIMIT										
1	2	3	4	5	6	7				
Rating	Status	D	L	S	V	FV				
TV-PG	View	V	B	V	V	V				
TV-MA	V	LSV	TV-G	V						
TV-14	V	DLSV	TV-Y7	VFV						
TV-PG	V	DLSV	TV-Y	V						

Press MENU to exit

Selecting TV-PG and the content theme Adult language (L) blocks all programs with Adult language (L) rated TV-PG and higher.

Remember: You must Lock Parental Controls for rating limits to take effect.

Using the TV/VCR Features

Viewing Specific Content Themes

After you block specific content themes, you have the option of going back and changing some of the content themes back to View (V).

1. Determine the rating you want to change to View (V).
2. Continuously press 1 until the rating status corresponding with the content theme(s) you want to change appears on screen.
3. To change the content theme to View (V), press the number on the remote that corresponds with the content theme you want to view.
4. After you press the number, the B should change to V in the content status field.

Note that only the content theme status corresponding to the rating you selected changes to View (V). Higher rated content themes, such as that for TV-MA language do not change to View (V).

V-CHIP TV RATING LIMIT						
1	2	3	4	5	6	7
Rating	Status	D	L	S	V	FV
TV-PG	View		B	V	B	B
TV-MA	B	LSV		TV-G		V
TV-14	B	DLSV		TV-Y7		VFV
TV-PG	V	DLSV		TV-Y		V

Press MENU to exit

Setting Movie Rating Limits

You set movie rating limits by blocking movies rated above a specified level. To access the V-CHIP MOVIE RATING LIMIT menu:

1. Press MENU to access the TV/VCR MAIN MENU.
2. Press 4 to display the PARENTAL CONTROLS menu.
3. Press 2 for the V-Chip Movie Rating Limit screen.

TV/VCR MAIN MENU	
1	Screen
2	Time
3	Timer Recordings
4	Parental Controls

PARENTAL CONTROLS	
1	V-Chip TV Rating Limit
2	V-Chip Movie Rating Limit

V-CHIP MOVIE RATING LIMIT			
Rating	Status	Rating	Status
1 NR	2 View		
NR	View	PG-13	View
X	View	PG	View
NC-17	View	G	View
R	View		

Press MENU to exit

Blocking Movie Ratings

If you only want your child to watch movies that have a PG rating and lower (in other words, movies rated PG and G), then you could automatically block out all other movies with higher ratings.

To block movies:

1. Determine the lowest level rating you do not want the child to watch.
2. Continuously press 1 until the lowest rating you do not want the child to watch appears as the rating. (In the example above, you would keep pressing 1 until the rating status scrolled to PG-13, since the highest rating you want the child to watch is PG.)
3. Press 2 to change the status from View to Block. All higher ratings' status will automatically change to Block.
4. Press MENU to exit.

- Press RESET to return all rating limits to VIEW.

V-CHIP MOVIE RATING LIMIT			
Rating	Status	Rating	Status
1 NR	2 Block		
NR	Block	PG-13	Block
X	Block	PG	View
NC-17	Block	G	View
R	Block		

Press MENU to exit

Change the status from View to Block and all higher rated movies will also be blocked.

Remember: You must Lock Parental Controls for rating limits to take effect.

Using the TV/VCR Features

Viewing Movie Ratings

After you block movie ratings, you have the option of going back and changing some of the rating statuses back to View.

1. Determine the movie ratings you want to change to View.
2. Continuously press 1 until the rating you want to change appears as the rating.
3. Press 2 to change the status from View to Block.

For example, if movies with a rating of PG-13 and higher are blocked, you can change the rating status button corresponding with NC-17. Your child would then be able to watch all movies with a G, PG, and NC-17 rating.

4. Press MENU to exit.

V-CHIP MOVIE RATING LIMIT			
Rating		Status	
1	Pg-13	2	View
NR	Block	PG-13	Block
X	Block	PG	View
NC-17	Block	G	View
R	Block		

Press MENU to exit

Viewing Movie Ratings: Pressing 2 on the remote changes the status back to View.

Blocking Unrated TV Programs

Some TV programs are not rated but may contain material you do not want your children to see. These programs must be blocked separately.

1. Press MENU to display the TV/VCR MAIN MENU.
2. Press 4 to display the PARENTAL CONTROLS menu.
3. Press 3 to select Unrated Programs from the menu and toggle between View and Block.

Note that unrated programs may include news, sports, political, religious, local and weather programs, emergency bulletins, public announcements and programs without a rating.

TV/VCR MAIN MENU	
1	Screen
2	Time
3	Timer Recordings
4	Parental Controls

PARENTAL CONTROLS	
1	V-Chip TV Rating Limit
2	V-Chip Movie Rating Limit
3	Unrated Programs: Block
4	Lock Parental Controls
0 Exit	

Press 3 to toggle between View and Block for Unrated Programs.

Lock/Unlock Parental Controls

Selecting this option lets you lock and unlock parental control settings using a password.

If you do not lock parental controls, none of the settings for V-Chip Rating Limits or Unrated Programs will take effect.

1. Press MENU to display the TV/VCR MAIN MENU.
2. Press 4 to display the PARENTAL CONTROLS menu.
3. Press 4 to display the LOCK PARENTAL CONTROLS screen.
4. Using the number buttons on your remote (0-9) enter a four-digit password. Press CLEAR to make any corrections and MENU to exit.

Once you have set your password, the V-Chip Rating Limit and Unrated Programs settings become active. If you try to access a program that is blocked, the screen displays the message "This channel has not been approved for viewing." Follow the instructions on the screen to enter your password and temporarily override the rating limits.

To unlock the parental controls you must use your password to access the PARENTAL CONTROLS menu.

1. Press MENU to display the TV/VCR MAIN MENU.
2. Press 4 to display the PARENTAL CONTROLS menu.
3. Follow the instructions on the screen and enter your password.
4. Press 4 to unlock PARENTAL CONTROLS.

If you forget your password, press STOP/EJECT on the TV/VCR front panel and MENU on the remote simultaneously. This resets the password, but not the limits you've set.

Remember: You must Lock Parental Controls for rating limits to take effect.

TV/VCR MAIN MENU	
1	Screen
2	Time
3	Timer Recordings
4	Parental Controls

PARENTAL CONTROLS	
1	V-Chip TV Rating Limit
2	V-Chip Movie Rating Limit
3	Unrated Programs: Block
4	Lock Parental Controls
0 Exit	

PARENTAL CONTROLS	
1	V-Chip TV Rating Limit
2	V-Chip Movie Rating Limit
3	Unrated Programs: Block
4	Unlock Parental Controls
0 Exit	

Operating Instructions

To Play a Tape

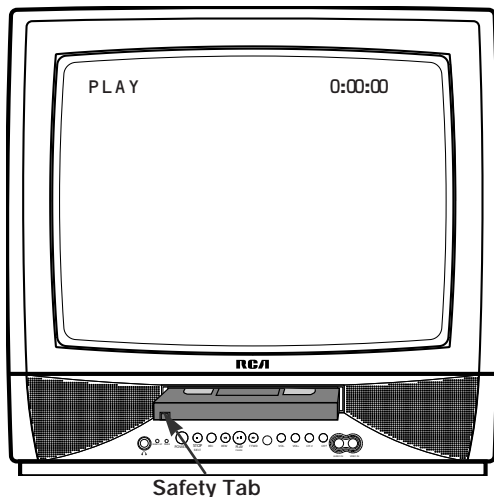

1. Insert a tape in the TV/VCR.
The TV/VCR automatically turns on. The tape automatically begins to play if the safety tab on the cassette has been removed and the Auto Play feature has been turned on.
2. Press PLAY, if necessary.
The word PLAY and the time counter appear on the screen.
3. If necessary, while the tape is playing, press TRACKING + or - on the remote or CHAN up or down on the TV/VCR to remove any streaks from the picture. *Details are on page 18*
4. Press STOP on the remote or STOP/EJECT on the TV/VCR to stop playback.
5. Press REW to rewind the tape. If the VCR is playing a tape when the REW button is pressed, the TV/VCR will search backwards through the tape. If the REW button is pressed while the TV/VCR is not playing a tape, the tape will rewind back to its start.
 - After the tape reaches its end during playback, it will automatically rewind back to the beginning of the tape and eject the tape.
 - Pressing the remote's OFF button while the tape is rewinding will not stop the tape. The tape will continue to rewind until it reaches its beginning, and then the TV/VCR will turn off.
6. Press FF to advance the tape. If the VCR is playing a tape when the FF button is pressed, the TV/VCR will search forward through the tape.
7. Press STOP/EJECT on the TV/VCR to eject the tape once it is completely rewound.
A cassette may be ejected if the power is turned off.

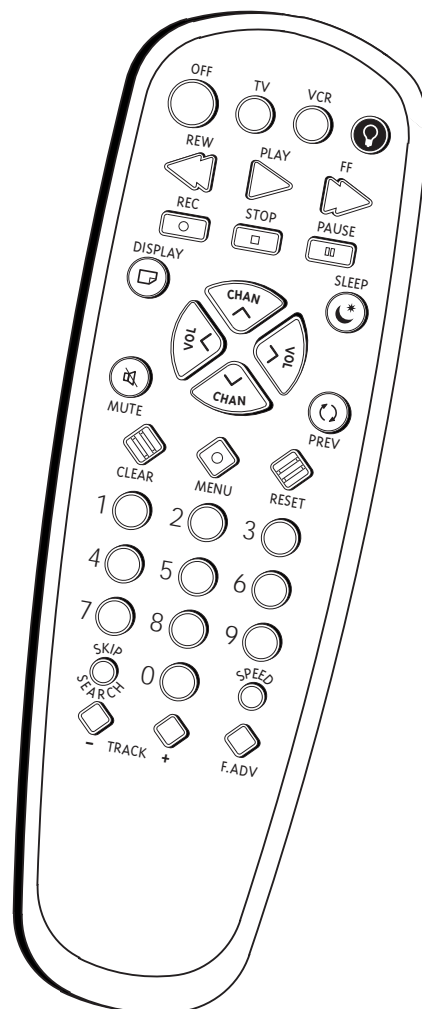

Using the Playback Features

Pause

This feature pauses the tape during playback and allows you to examine the details of the scene. Pause works best with tapes recorded in SLP speed.

1. Press PAUSE on the remote during playback to pause the action.

The TV/VCR will automatically switch from pause to stop after a few minutes to prevent tape wear.

2. Press PAUSE or PLAY to return to normal playback.

Frame Advance

Frame advance lets you view one frame at a time while in the PAUSE mode. Frame advance works best with tapes recorded in SLP speed.

1. Press PAUSE during playback to pause the action.
2. Press F. ADV each time you want to view the next frame of the scene.
Press and hold F. ADV to view the tape frame-by-frame.
3. Press PAUSE or PLAY to return to normal playback.

Picture Search

You can visually search a picture during playback. Sound is turned off during picture search. Picture search works best for tapes recorded in SLP speed.

1. During playback, press FF to search forward or REW to search in reverse.
2. Press PLAY to return to normal playback.

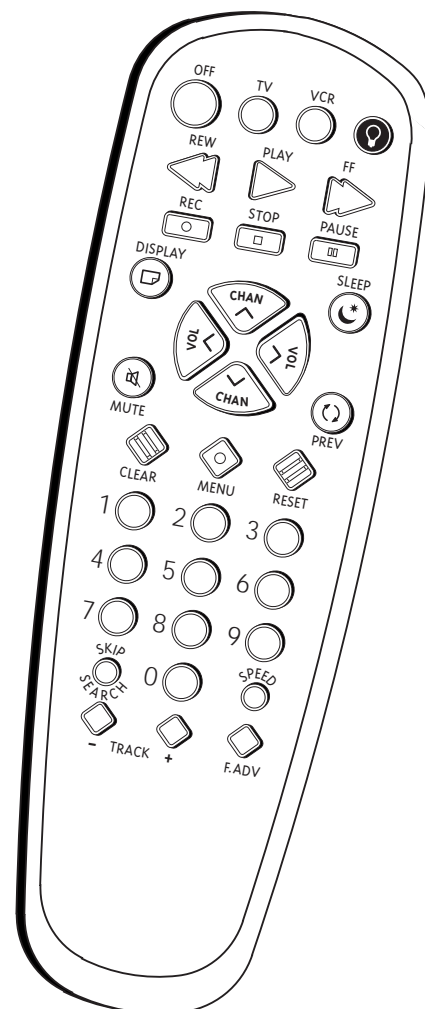

Using the Playback Features

Automatic Tracking

The TV/VCR has automatic tracking which adjusts the picture when playing a tape that was recorded on another VCR. Automatic tracking is turned on whenever a tape is inserted or the TV/VCR's power is turned on.

Manual Tracking

Occasionally, you may need to manually adjust tracking on a tape recorded on a different VCR or camcorder. Tracking is used when playing a tape. It has no effect during recording.

- When streaks or snow appear in the picture during normal playback or slow motion, press TRACK + or - on the remote or CHANNEL up or down on the TV/VCR for the best possible picture.
- To return to Automatic Tracking the tape must be removed from the VCR and re-inserted.

Time Counter

The time counter helps locate the beginning or end of programs you taped. The time counter automatically resets to 0:00:00 whenever a tape is inserted, or you can press CLEAR when the time counter is displayed. For example, if a 30-minute program was recorded at the beginning of the tape and you wanted to record another program after it, you should:

1. Insert the pre-recorded tape.
2. Press DISPLAY twice to display the time counter and fast forward the tape until 30 minutes appears on the screen. Then you can begin recording a second program.

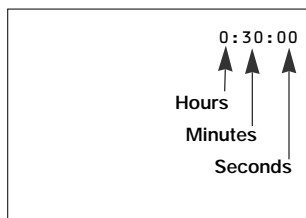

This is the approximate end of the program and you can begin recording at this spot.

3. Press DISPLAY again or eject the tape to remove the time counter from the screen.

Commercial Scan

This is useful for skipping commercials or short program segments. Press SKIP/SEARCH during playback to advance the tape approximately 60 seconds.

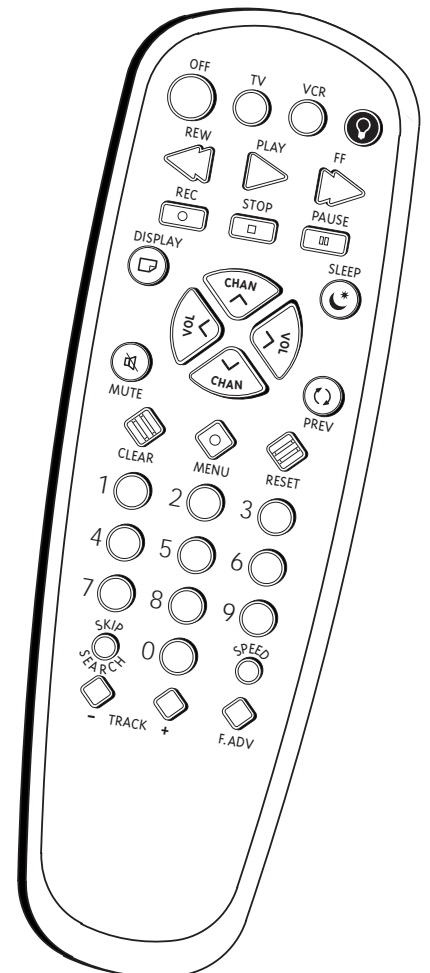

Using the Playback Features

Auto Play Feature

This feature enables the TV/VCR to automatically start playing a tape when it is inserted. (The safety tab on the tape must be removed.)

1. Press MENU to display the TV/VCR MAIN MENU.
2. Press 5 to display the SETUP menu.
3. Press 4 to change the Auto Play setting.

The Auto Play feature is set to ON at the factory.

- Select ON if you want a tape with its safety tab removed to start playing automatically.
- Select OFF if you do not want a tape with its safety tab removed to start playing automatically.

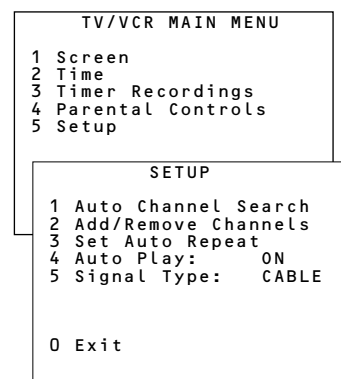

Auto Repeat Feature

This feature tells the TV/VCR to play a tape (or part of a tape) continuously. The TV/VCR will automatically rewind the tape, or a selected portion of the tape, and play it repeatedly.

1. Using REW, FF, or PLAY, go to the place on the tape that you want to be the **beginning** of the section that automatically repeats. Reset the time counter to 0:00:00 by pressing DISPLAY, then CLEAR.
2. Using FF or PLAY, go to the place on the tape that you want to be the **end** of the section that plays continuously. Remember the numbers on the time counter. (2:55 is the end time for AUTO REPEAT in the example to the right.)
3. Press MENU to display the TV/VCR MAIN MENU.
4. Press 5 to display the SETUP menu.
5. Press 3 to display the AUTO REPEAT menu.
6. Using the number buttons, enter the amount of time you want the tape to repeat (the number from Step 2). In the example at right, the section that the TV/VCR will automatically repeat is 2:55 – two hours, 55 minutes long.

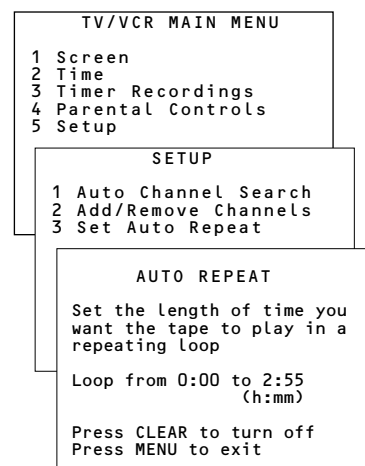

To Cancel Auto Repeat

Press MENU, 5, 3, and CLEAR.

Using the Playback Features

Index Search

The TV/VCR automatically records index marks on the tape each time you begin recording. During playback you can locate the program you want to play by the number of index marks. Your TV/VCR has two index playback features. You can select a specific index number or search by scan and play.

To Select Scan and Play Index Playback

1. Insert the pre-recorded tape and press STOP.
2. Press SKIP/SEARCH to display the INDEX SEARCH screen.
3. Press FF to scan forward or REW to scan in reverse.
When the TV/VCR locates an index mark, it will stop and play a few seconds of the program following the mark.
4. At any time during the search, press PLAY to stop searching and begin playback, or press STOP to stop the search.
If the beginning or end of the tape is reached during the search, the message **End of tape** appears.

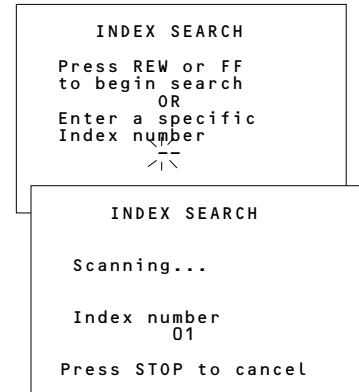

To Select a Specific Index Number for Index Playback

1. Insert the pre-recorded tape and press STOP.
2. Press SKIP/SEARCH to display the INDEX SEARCH screen.
3. Use the number buttons on the remote control to enter the number of the index mark for which you want the TV/VCR to search.
4. Press FF to search forward or REW to search in reverse.
When the TV/VCR locates the index mark, it will begin playback.

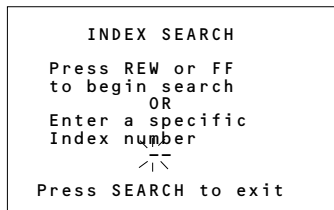

When using index playback, the following index marks may be skipped by the TV/VCR.

- The mark closest to the current location on the tape.
- The mark at the beginning of a recorded segment that is five minutes or less.
- The mark at the beginning of the tape.

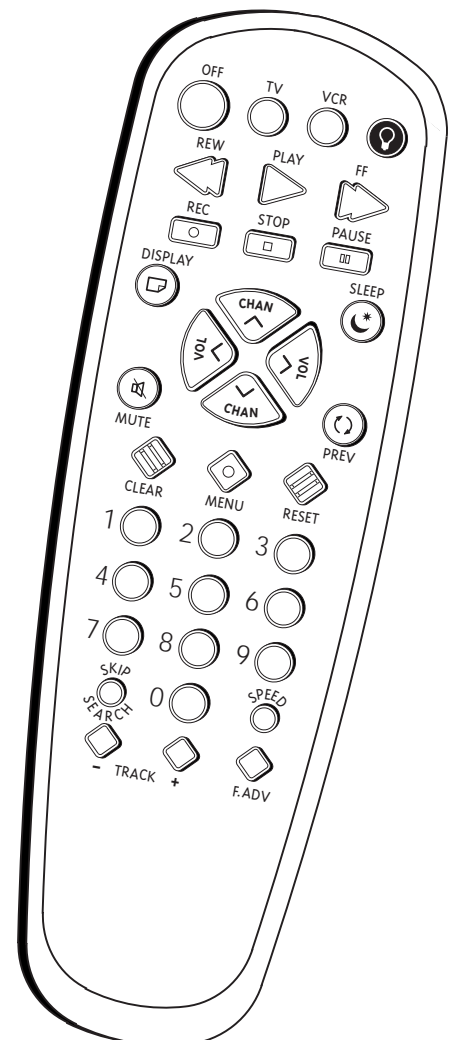

Using the Playback Features

Zero Search

This feature allows you to quickly return to a time counter reading of 0:00:00. This is especially convenient when you want to watch a segment of the tape several times.

1. Insert the pre-recorded tape and press STOP.
2. Press DISPLAY twice to display only the time counter.
3. Use PLAY, FF, or REW to locate the start of the segment you want to repeat.
4. Press CLEAR to reset the time counter to 0:00:00.
5. Continue playing the tape and press STOP when you reach the end of the segment you want to repeat.
6. Press SKIP/SEARCH twice to display the ZERO SEARCH screen. The current time counter is displayed.
7. Press REW or FF to return to 0:00:00.
The tape rewinds or fast forwards to the 0:00:00 and begins playing.

```
ZERO SEARCH

Current tape counter is
0:12:34

Press REW to go to
0:00:00

Press SEARCH to exit
```

— OR —

```
ZERO SEARCH

Current tape counter is
-0:12:34

Press FF to go to
0:00:00

Press SEARCH to exit
```

Blank Search

The TV/VCR will search for blank portions of the tape that are more than six seconds in length.

1. Insert the pre-recorded tape and press STOP.
2. Press SKIP/SEARCH three times to display the BLANK SEARCH screen.

```
BLANK SEARCH

Press FF to begin searching
for blank section of tape.

Press SEARCH to exit
```

3. Press FF to begin searching for a segment that is at least six seconds of blank tape.
4. Press STOP to stop BLANK SEARCH.

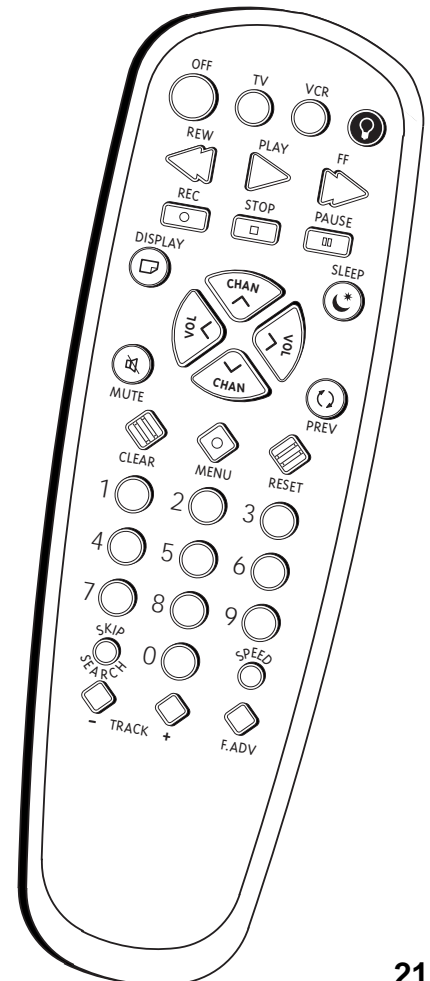

Recording Features

Recording Speeds

Press SPEED to select a recording speed.

Cassette	Recording Time		
	SP	SLP	LP
T-120	2Hrs	6Hrs	4Hrs
T-160	2Hrs 40Min	8Hrs	5Hrs 20Min

- SP (Standard Play) gives the best quality recording. That is why most pre-recorded, rental tapes are recorded in SP. Fewer programs can be recorded on the tape.
- SLP (Super Long Play) gives three times the recording time of tapes recorded in SP. Special effects such as pause, slow motion, picture search, and frame advance work in this speed.
- LP (Long Play) gives twice the recording time of tapes recorded in SP. Special effects are not recommended in this speed.

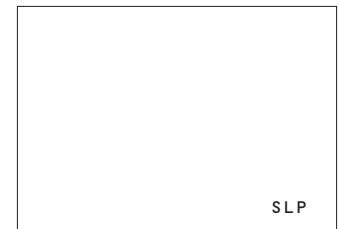

↑
Tape Speed Indicator

Recording Pause

This feature allows you to prevent recording short passages of unwanted material.

- Press PAUSE during recording to temporarily stop and start recording.
While the tape is paused, the front panel indicator light inside the REC button will flash.
The TV/VCR will automatically switch from pause to stop after a few minutes to prevent tape wear.

Automatic Head Cleaner

The TV/VCR has an automatic head cleaner system. When a cassette is inserted, the head cleaning system is activated. This system minimizes the need for accessory cleaners or a visit to a Servicenter.

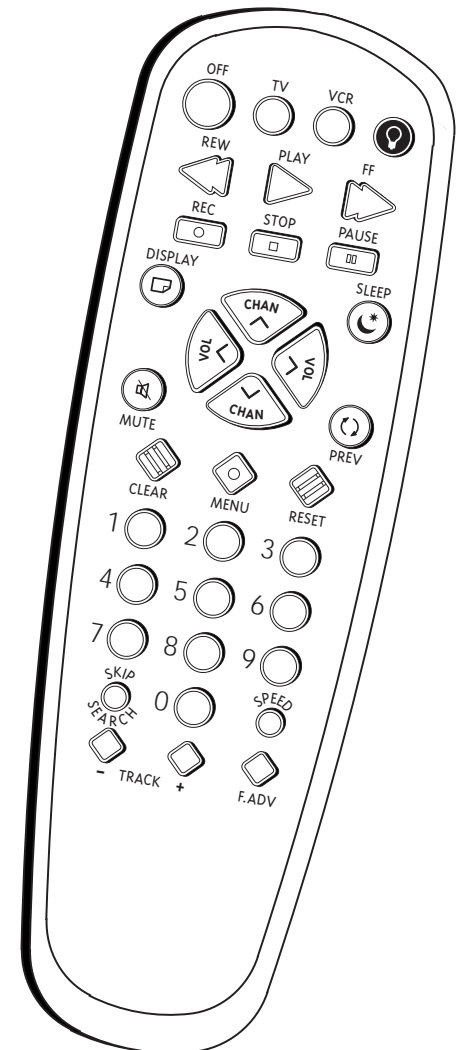

Types of Recordings

Your TV/VCR provides different ways to record which are explained in the following sections:

- Basic Recording**
- Express Recording**
- Timer Recording**
- Copying and Editing Tapes**

Basic Recording

How to Make a Recording

1. Insert a tape with safety tab in place.
2. Press SPEED to select a recording speed.
The tape speed indicator appears.
3. Select the channel to be recorded.
To record from the AUDIO/VIDEO IN jacks, press 00.
Two selections appear in the channel field. Press 1 to select VIDEO 1, the rear AUDIO/VIDEO IN jacks. Press 2 to select the front panel AUDIO/VIDEO IN jacks.
4. Press REC to begin recording.
The indicator light in the REC button on the front of the TV/VCR turns on during recording.
5. Press STOP/EJECT on the TV/VCR or STOP on the remote to stop recording.

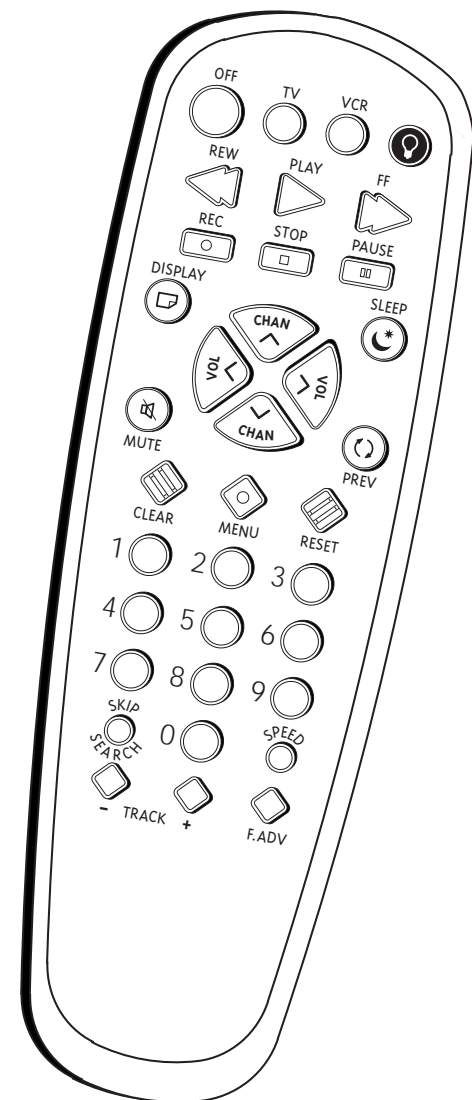

Express Recording

Express recording lets you record up to four hours or to the end of the tape without programming the timer. You can begin recording immediately. The TV/VCR will stop automatically at the end of the recording.

How to Use Express Recording

1. Insert a tape with safety tab in place.
The TV/VCR will turn on.
2. Select the channel to be recorded.
To record from the AUDIO/VIDEO IN jacks, press INPUT. Two selections appear in the channel field. Press 1 to select VIDEO 1, the rear AUDIO/VIDEO IN jacks. Press 2 to select the front panel AUDIO/VIDEO IN jacks.
3. Press SPEED to select a recording speed.
You can also change the speed of the recording in progress.
4. Press REC twice to activate express recording.
5. Press REC repeatedly until the desired amount of recording time is displayed.
Each time you press REC, the recording time increases as shown below:

	Press REC	Recording Time
<div style="border: 1px solid black; padding: 5px; width: fit-content;"> RECORD LENGTH 0:00 Ch 04 Press REC to set length </div> <p style="text-align: center;">Display</p>	→	0:30 (30 Min)
		1:00 (1 Hr)
		1:30 (1 Hr, 30 Min)
		2:00 (2 Hrs)
		3:00 (3 Hrs)
		4:00 (4 Hrs)
		0:00:00 (Normal Record)
		0:00 (Turns Off)

The TIMER REC indicator on the TV/VCR's front panel will light during express recording.

During express recording, press REC to display the time remaining on the screen. Press REC again to increase the recording time.

Stopping an Express Recording in Progress

Press and hold STOP/EJECT on the TV/VCR or STOP on the remote to stop the express recording.

— OR —

Repeatedly press REC until RECORD LENGTH: 0:00 appears. The recording stops after a few seconds.

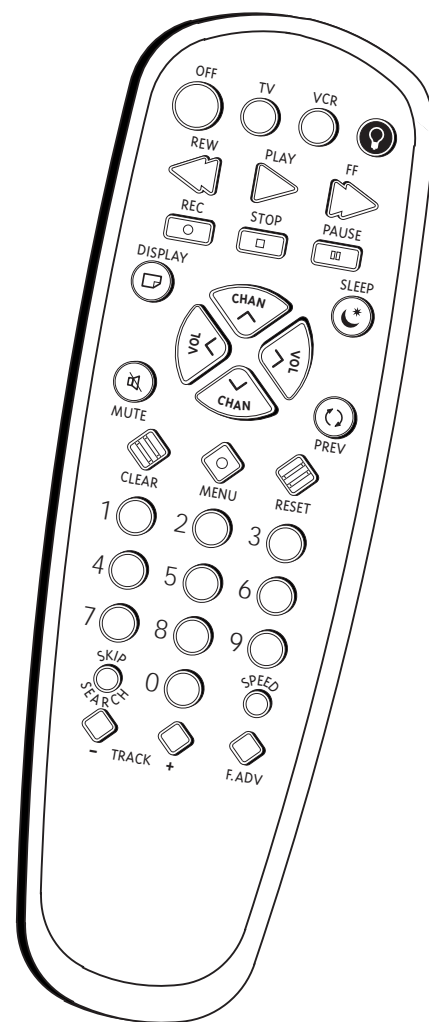

Timer Recording

Timer recording lets you program the TV/VCR to record up to eight different programs. This is useful if you plan on being away from home for a long period of time. Before setting the timer, make sure that the clock is set correctly.

Setting a Timer Recording

1. Press MENU to display the TV/VCR MAIN MENU.
2. Press 3 to display the TIMER RECORDINGS menu.
3. Press 1 to Create a New Program.
4. Press 1, 2, 3, or 4 to select the type of program.
 - 1 One time — single program recorded once.
 - 2 Daily — program recorded at same time every day.
 - 3 Weekdays — program recorded at same time Monday through Friday.
 - 4 Weekly — program recorded at same time once a week.
5. Use the number buttons to enter the channel number, start time including AM or PM, end time, and start date of the recording. Just follow the on-screen prompts.
 - To record from the AUDIO/VIDEO IN jacks, press INPUT. Two selections appear in the channel field. Press 1 to select VIDEO 1, the rear AUDIO/VIDEO IN jacks. Press 2 to select the front panel AUDIO/VIDEO IN jacks.

Press CLEAR to correct an entry.
6. Press SPEED to select a recording speed.
7. Press MENU to save your program.
8. Repeat steps 3 – 6 for additional programs.
9. Insert a tape with safety tab intact before the recording is to begin.

The TIMER REC indicator lights in the TV/VCR's front panel.

If you turn the TV/VCR off, the TIMER REC indicator will flash if there is no cassette in the TV/VCR or the safety tab is missing from the cassette.

10. If using a cable box, turn it on and tune it to the channel you want to record before time for the recording to begin.

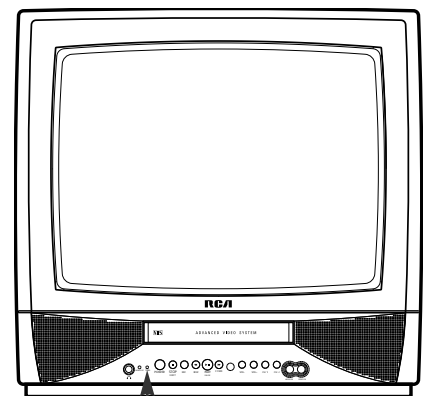
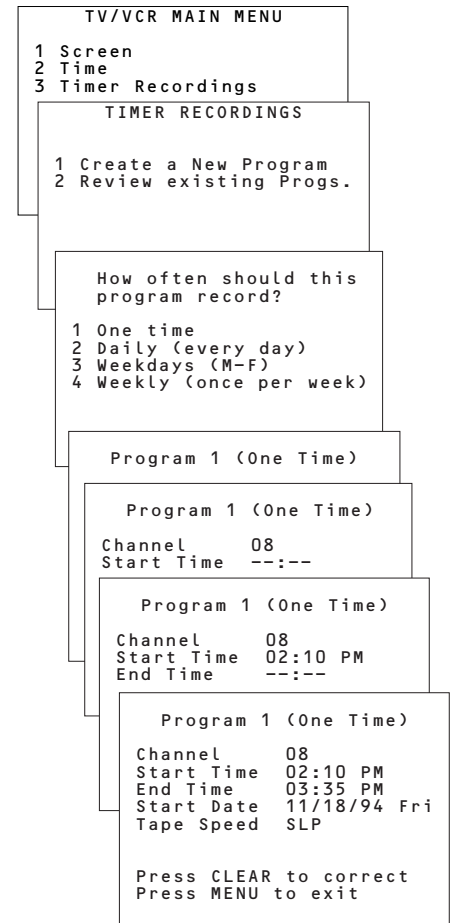

TIMER RECORD Indicator

Timer Recording

Checking or Clearing Timer Recordings

1. Press MENU on the remote to display the TV/VCR MAIN MENU.
2. Press 3 to display the TIMER RECORDINGS menu.
3. Press 2 to Review Existing Progs. (programs).
4. Press CLEAR to erase a program.
5. Press MENU to review the next program in sequence.
 - After you have reviewed all of your programs press MENU to exit.

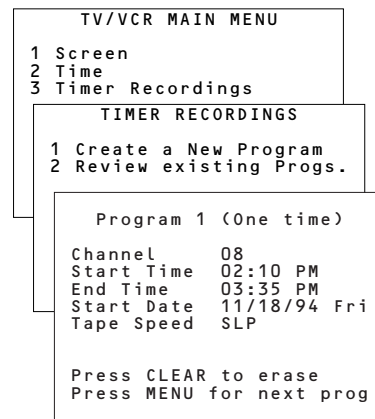

Stopping A Timer Recording

1. Press and hold STOP/EJECT on the TV/VCR or STOP on the remote.

A timer program in progress will be stopped. Only today's recording of a Daily, Weekdays, or Weekly program is canceled. The Daily, Weekdays, or Weekly program remains in the timer.

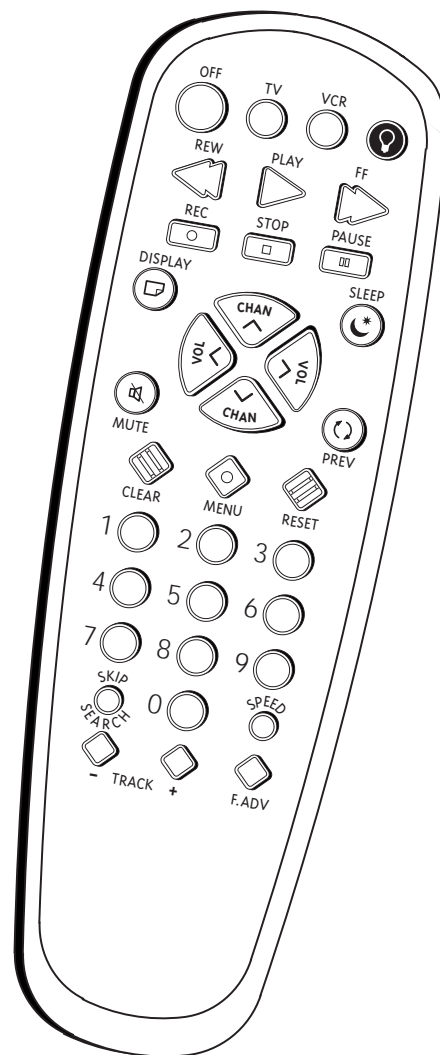

Copying and Editing Tapes

Operating Instructions (Refer to hookup on page 30.)

Caution: The unauthorized recording of television programs and other materials may infringe upon the rights of others.

Use another VCR or camcorder as the playback VCR and the TV/VCR as the recording VCR.

1. Turn on the VCR or camcorder and the TV/VCR.
2. Press 00 on TV/VCR's remote to select the line input (VIDEO1 or VIDEO2). Pressing 00 once tunes the TV/VCR to the AUDIO/VIDEO1 input jacks on the **rear** of the TV/VCR. Pressing 00 twice tunes the TV/VCR to the AUDIO/VIDEO2 input jacks on the **front** of the TV/VCR.
3. Insert the tape you want to copy into the playback VCR or camcorder. Insert a blank tape with safety tab intact into the TV/VCR.
4. Start the playback VCR or camcorder playing. If the tape was not recorded on the playback VCR, streaks may appear and you may need to adjust the tracking. When you reach the place you want to begin copying, place the playback VCR or camcorder in play pause.
5. Press REC, then PAUSE, on the TV/VCR's remote.
6. Press PAUSE on **both** the VCR or camcorder and the TV/VCR's remote **at the same time** to begin copying the tape.
7. Edit out segments that you do not want to copy by pressing PAUSE on the TV/VCR's remote to pause the tape. Then, locate the next segment you want to copy on the playback VCR or camcorder by using FF, REW, or PLAY. Press PAUSE on the playback VCR or camcorder. Press PAUSE **at the same time on both** the VCR or camcorder and the TV/VCR's remote to resume copying.
8. Press STOP on **both** the VCR or camcorder and the TV/VCR's remote when you are finished.

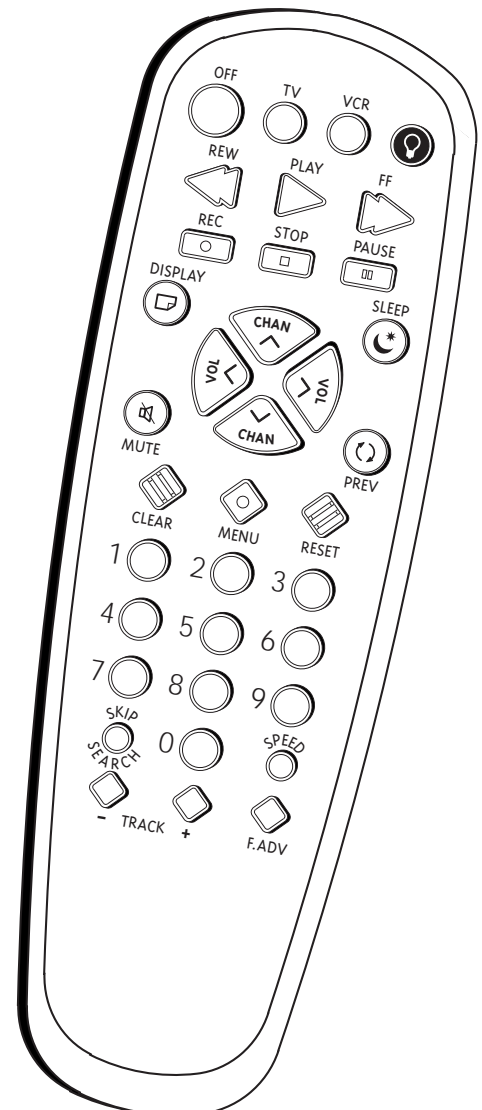
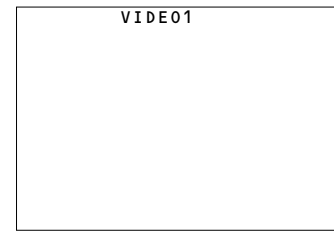

Front Panel

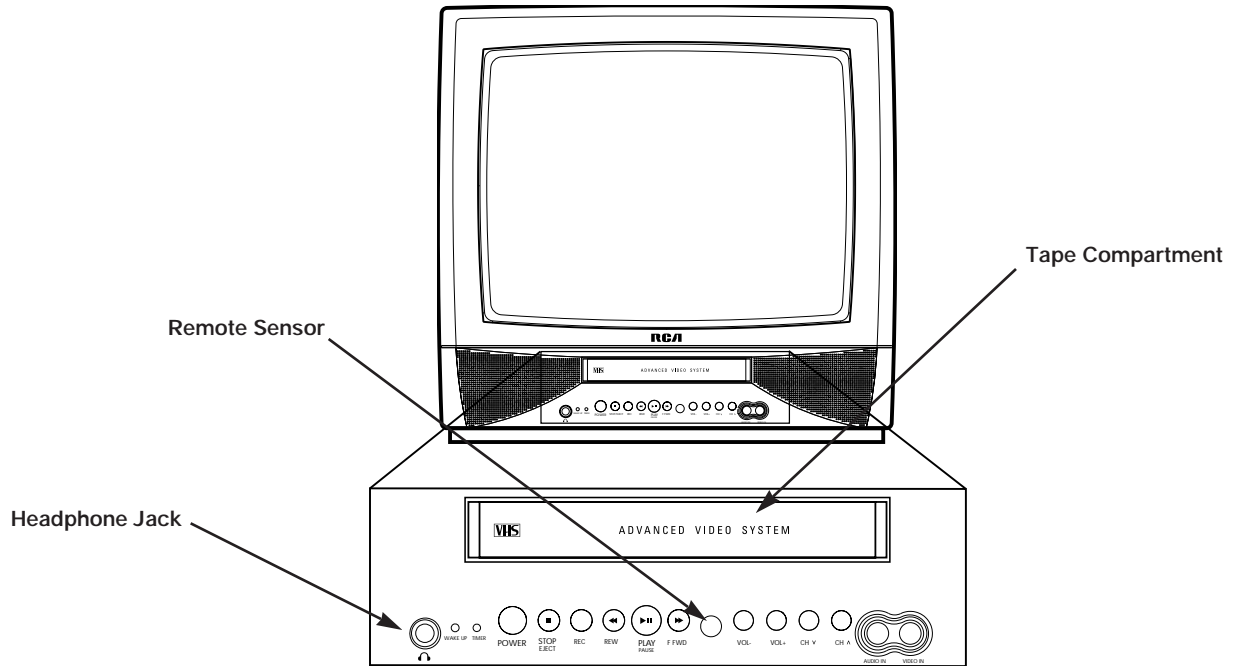

AUDIO IN and VIDEO IN Jacks

Receives audio and video signals from another component, like a VCR or camcorder when it is connected to these jacks.

To select these front panel jacks, press 00 twice to display VIDEO2.

CH ^ and v (Channel up and down)

Selects next higher or lower channel in the TV/VCR's channel memory.

Used for manual tracking when a tape is playing.

F. FWD (Fast Forward)

Fast forwards the tape when the VCR is stopped. Searches the picture forward during playback.

Headphone Jack

Connect headphones (not supplied) to this jack.

PLAY/PAUSE

Press once to begin playback of a tape. During playback, press to pause. Press again to resume playback.

POWER

Turns the TV/VCR on or off. The indicator in the button is lit when the power is on.

REC (Record)

Press to start TV/VCR recording. The indicator in the button lights during recording.

Remote Sensor

Receives signals from the remote. Aim remote at this sensor with no objects between them.

REW (Rewind)

Rewinds the tape when the TV/VCR is stopped. Searches the picture in reverse during playback.

STOP/EJECT

Stops normal functions such as record, play, rewind, fast-forward, or pause.

Press when a tape is stopped to eject the cassette.

TIMER Indicator

Lights when a timer program has been set and a cassette with safety tab in place is in the TV/VCR.

Flashes when a timer recording has been set and the TV/VCR is turned off with no cassette inserted, a cassette with no safety tab has been inserted, or there has been a power interruption.

WAKE-UP Indicator

Lights when the wake-up timer turns on the TV/VCR.

VOL + and - (Volume up and down)

Raises and lowers the sound.

Note:

To disable Front Panel Buttons, see Front Panel Block on page 10.

Back Panel



IN FROM ANTENNA Jack

Receives the signal from an antenna or cable system.

VIDEO and AUDIO INPUT Jacks

Receive signals from another component, such as a VCR or camcorder, when it is connected to these jacks.

To select these back panel jacks, press 00 once to display VIDEO1.

Hooking Up the TV/VCR

Choosing a Hookup

Answer the questions to choose the hookup for your TV/VCR.

1. How does your TV/VCR receive signals?
Choose one answer from below.
 - A. Dipole antenna – See page 30, Section A.
 - B. Outside antenna – See page 30, Section B.
 - C. Cable System – Go to question 2.

2. What type of Cable-TV system* do you have?
Choose one answer from below.
 - A. Cable without a box – See page 30, Section B.
 - B. Cable box to unscramble all channels – See page 31, Section A.
 - C. Cable box to unscramble only premium channels, such as HBO, Showtime, Cinemax, etc. – See page 31, Section B.

*You may need to contact your local cable company for assistance.

Optional Hookup

To hook up a VCR or camcorder for copying tapes — Turn to page 32.

Connect Antenna or Cable System Without a Cable Box

A. Dipole Antenna

Follow these steps to connect a dipole antenna to your TV/VCR. Do not connect a dipole antenna if you plan to connect a different type of indoor or outdoor antenna or cable system. This connection may require additional accessories not provided.

1. **Insert the antenna base into the slot on the back of your TV/VCR.**
2. **Connect the twin-lead ends of the antenna to the screw terminals of an antenna adapter.**
3. **Connect an antenna adapter to the IN FROM ANTENNA jack on the back of the TV/VCR.**
4. **Plug in the TV/VCR's power cord.**
5. **Turn to pages 2-5 for "Setting Up the TV/VCR."**

Adjust the length and position of the antenna rods for the best reception.

- For viewing VHF channels, extend the rods fully.
- For UHF viewing, shorten the rods.

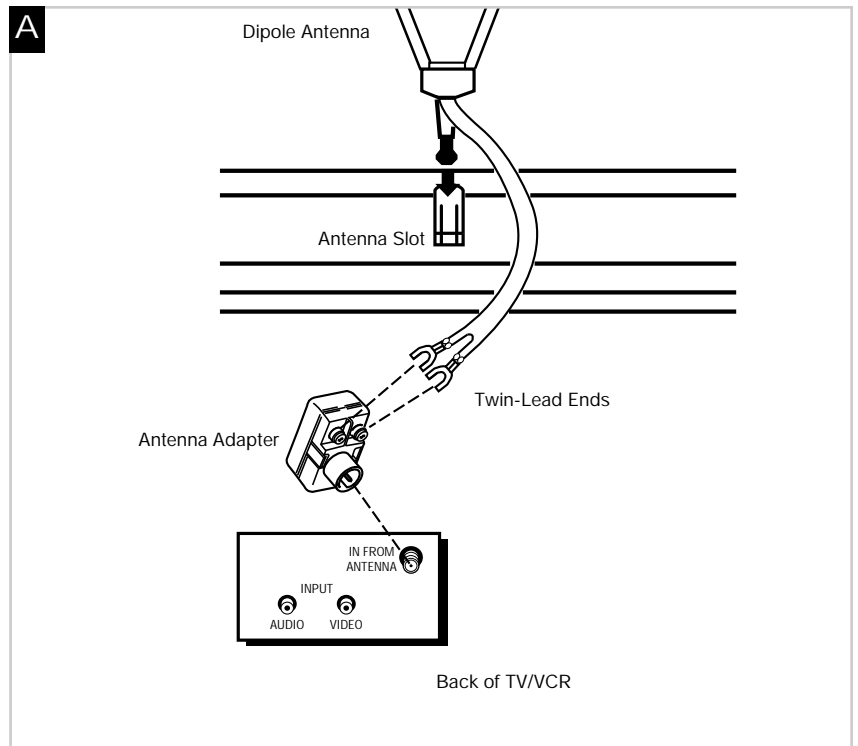

B. Outside Antenna, Set-top Antenna, or Cable System Without a Cable Box

1. **Connect as shown.**
This connection may require additional accessories not provided.
2. **Plug in TV/VCR's power cord.**
3. **Turn to pages 2-5 for "Setting Up the TV/VCR."**

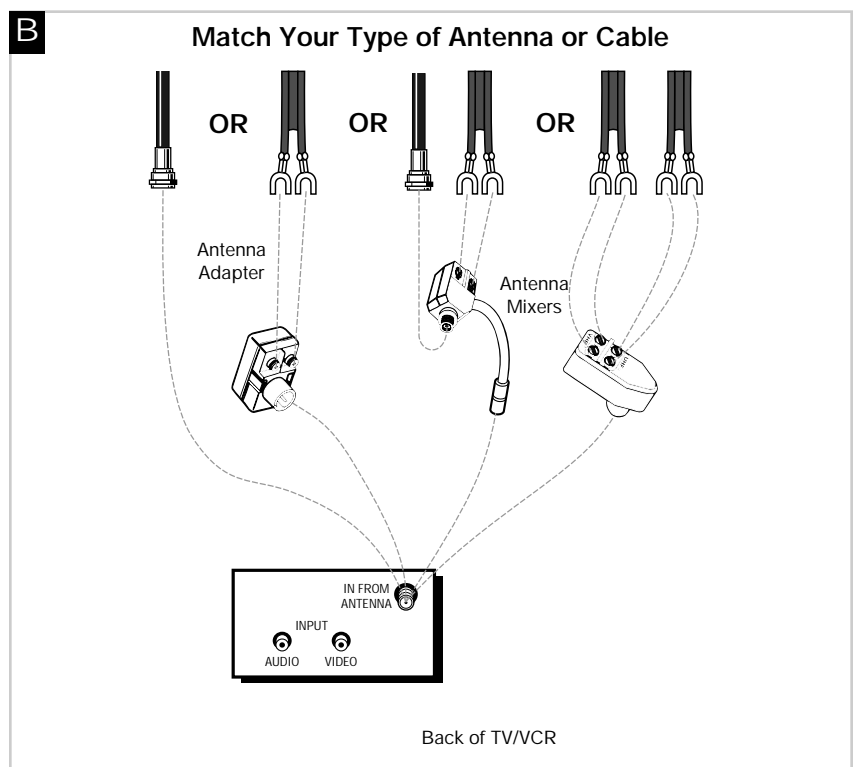

Connect a Cable System With a Cable Box

A. Cable Box Required to Unscramble All Channels

1. Connect as shown.

This connection may require additional accessories not provided.

2. Plug in power cords of TV/VCR and cable box.

3. Turn to pages 2-5 for "Setting Up the TV/VCR."

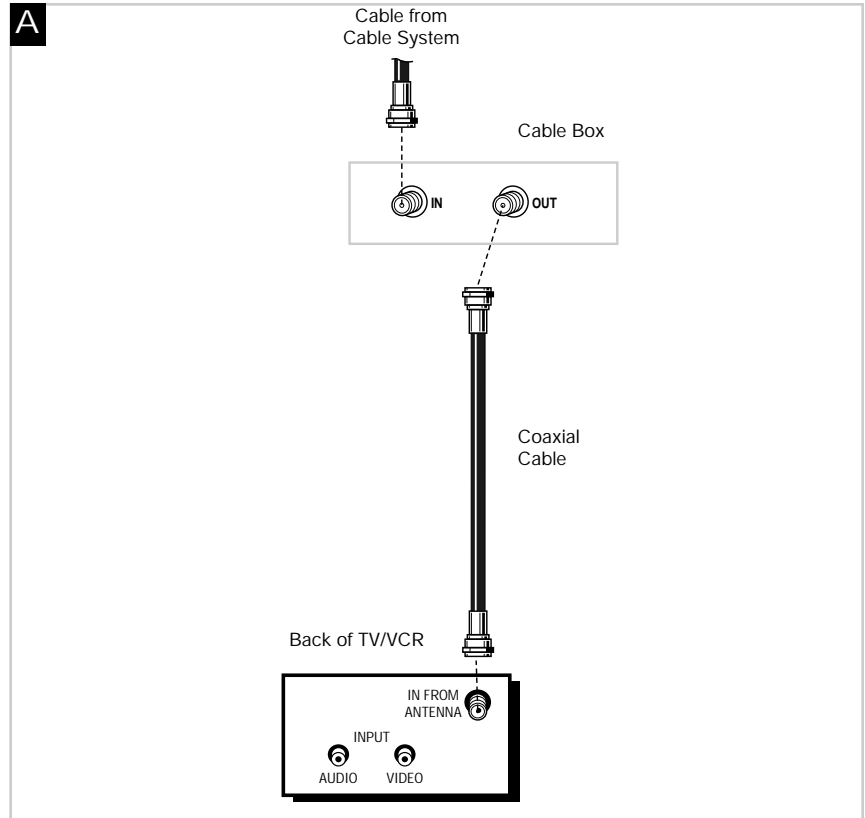

B. Cable Box Required to Unscramble Premium Channels Only

1. Connect as shown.

This connection requires additional accessories not provided.

2. Plug in power cords of TV/VCR and cable box.

3. Operation

Place the A-B switch in the B position to watch premium channels. Place the A-B switch in the A position to watch other channels when cable box is not needed.

4. Turn to pages 2-5 for "Setting Up the TV/VCR."

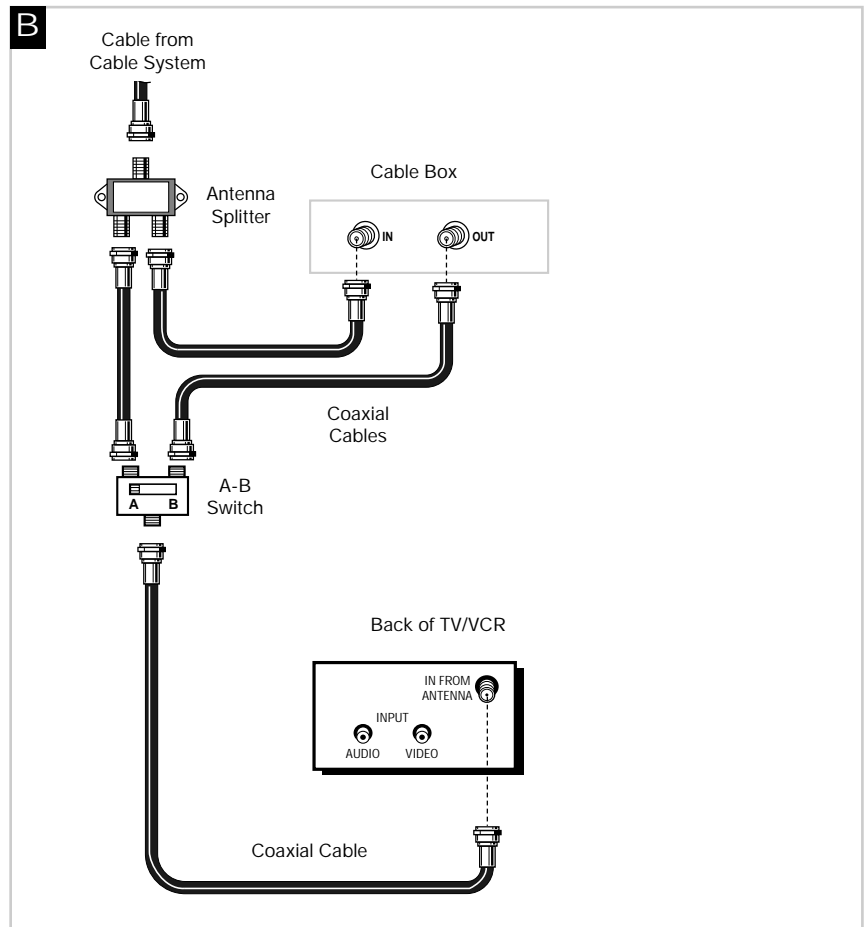

Connect a VCR or Camcorder for Copying Tapes

A. VCR for Copying Tapes

1. Connect as shown.

This connection requires additional accessories not provided.

2. Plug in power cords of VCR and TV/VCR.

3. Turn to page 27 for “Copying and Editing Tapes.”

Press 00 on the remote to select the line (audio/video) inputs on the TV/VCR to receive the signal from the VCR.

If your VCR has stereo AUDIO OUT jacks, connect the audio cable to the jack labeled MONO. If neither jack is labeled MONO, you may need a Y- adapter to hear both channels.

Caution: The unauthorized recording of television programs and other materials may infringe upon the rights of others.

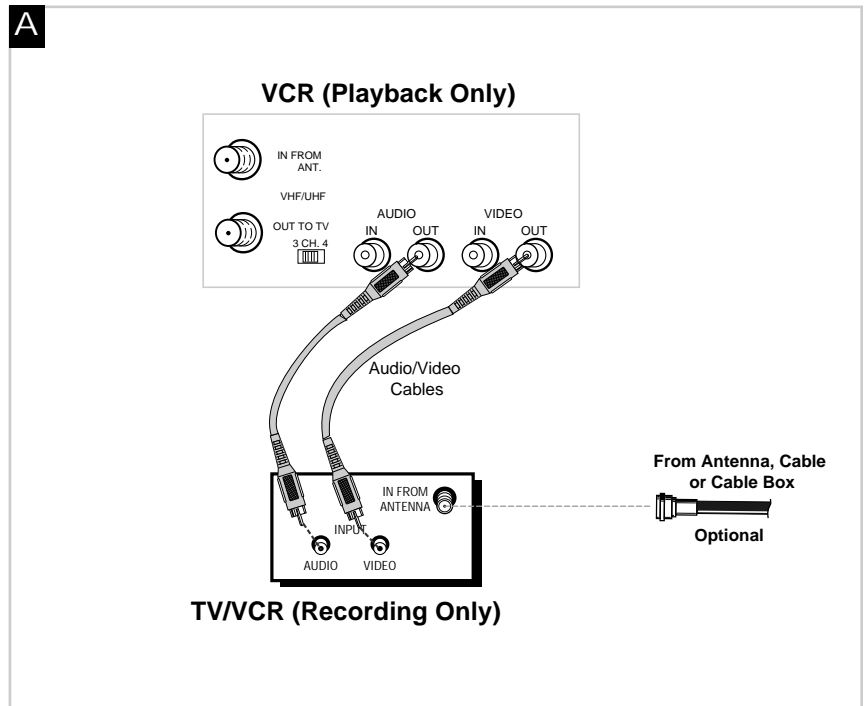

B. Camcorder for Copying Tapes

1. Connect as shown.

This connection requires additional accessories not provided.

2. Plug in TV/VCR's power cord.

3. Turn to page 27 for “Copying and Editing Tapes.”

Press 00 on the remote to select the line (audio/video) inputs on the TV/VCR to receive the signal from the camcorder.

If your camcorder has stereo AUDIO OUT jacks, you may need a Y- adapter to hear both channels.

Caution: The unauthorized recording of television programs and other materials may infringe upon the rights of others.

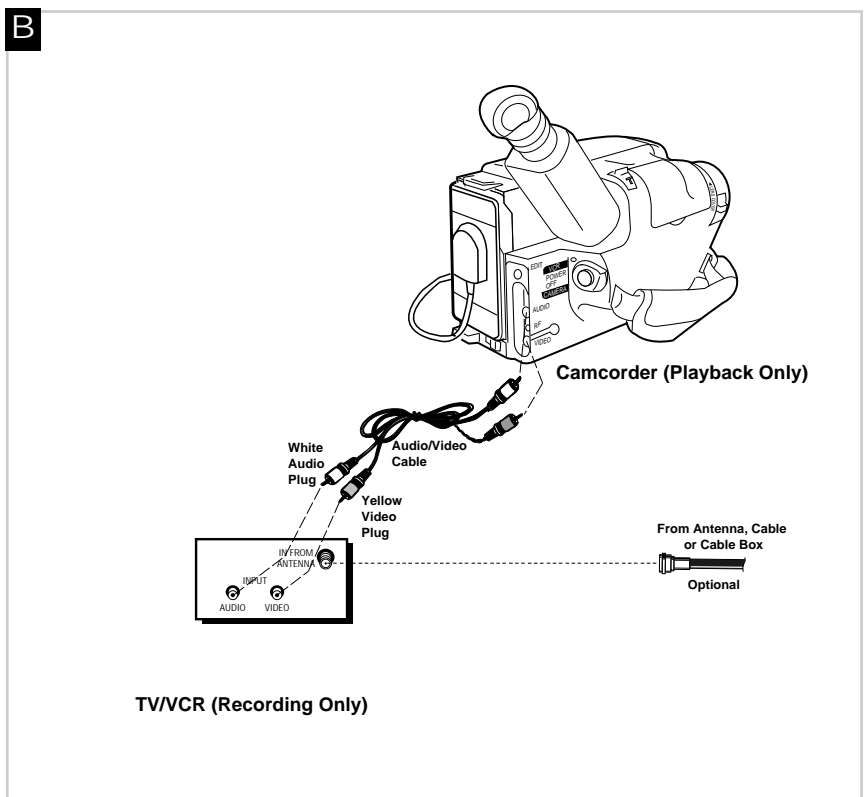

Trouble Checks

Sometimes problems can be easily solved by checking a few basic things. Check below before you call for help or take your TV/VCR to an Authorized RCA VCR Servicenter.

Problem	Solution
No power	<ul style="list-style-type: none"> • Plug TV/VCR into an operating outlet. • Check connections. • Make sure the wall outlet is not controlled by a wall switch.
TV/VCR does not respond to remote	<ul style="list-style-type: none"> • Aim remote at TV/VCR's remote sensor with no objects between them. • Change batteries and make sure they are properly installed.
Poor or no picture during TV viewing	<ul style="list-style-type: none"> • Switch to an active channel. • Check antenna connections. If using a dipole antenna, try adjusting its rods. • Check picture adjustments. <i>See page 8.</i> • Make sure the line input is not selected. Repeatedly press 00 on the remote to switch between audio/video input jacks and tuner.
No sound	<ul style="list-style-type: none"> • Press VOLUME up to increase sound. • Sound has been muted. Press MUTE on remote or VOLUME up.
Snow or streaks in picture or no picture during tape playback	<ul style="list-style-type: none"> • Check tape — it may be worn out or of poor quality. Try another tape. • Some snow/streaks are normal during search, pause, frame advance, and slow-motion playback. • Press one of the TRACKING buttons on the remote or CHANNEL up or down on the TV/VCR to move the streaks up or down and out of the picture.
Will not record or play	<ul style="list-style-type: none"> • No cassette in TV/VCR. • Eject and re-insert cassette. • Broken tape — try another cassette. • Safety tab removed from cassette — TV/VCR will not record. • TV/VCR is in pause mode. Press PAUSE on the remote.
Cannot insert or eject tape	<ul style="list-style-type: none"> • Insert cassette with window facing up and safety tab facing out. • To remove cassette, TV/VCR must be connected to working outlet. • Turn POWER off and then on before trying to insert or remove cassette.
Time counter not working	<ul style="list-style-type: none"> • Press DISPLAY on remote to display time counter on screen. <i>See page 18.</i> • The time counter does not advance during unrecorded portions of tape. When an unrecorded segment of tape is encountered, the time counter will hold its count until recorded material is detected again. • A minus (-) will appear in front of the time counter if you rewind the tape farther back than a counter reading of 0:00:00.
Rewind does not operate	<ul style="list-style-type: none"> • Tape already rewound.
Timer recording not made or wrong program recorded	<ul style="list-style-type: none"> • Program entered incorrectly (wrong channel or times). <i>See page 25.</i> • Cable box was not turned on and tuned to the correct channel at time recording was to begin. • Power interruption. TIMER REC indicator flashes on front of TV/VCR. • Check to see if the TV/VCR's time and date are correct — including AM/PM. <i>See page 5.</i> • Program exceeded tape's length or tape was not rewound beforehand. • No tape in TV/VCR, or cassette ejected if safety tab broken off.

Trouble Checks

Problem	Solution
Clock shows incorrect time or date	<ul style="list-style-type: none"> • Power interruption. TIMER REC indicator flashes on front of TV/VCR. • Clock was not set accurately (check AM/PM and date). <i>See page 5.</i>
TV/VCR makes noise when stopped	<ul style="list-style-type: none"> • TV/VCR is removing tape from heads. This is normal. The head cylinder inside the TV/VCR will continue to rotate for a few minutes after you put the VCR in the stop mode.
Will not auto channel search active channels correctly	<ul style="list-style-type: none"> • Check antenna or cable connections.
Cannot see closed captions on screen	<ul style="list-style-type: none"> • Closed caption function must be set to on. <i>See page 9.</i> • Station may not be broadcasting closed captions.
Box appears on screen	<ul style="list-style-type: none"> • A text feature has been selected. <i>See page 9.</i>
TIMER REC indicator on front of TV/VCR is flashing	<ul style="list-style-type: none"> • Power interruption. Check time and date setting (clock). <i>See page 5.</i> • Timer program set and TV/VCR turned off with no cassette or cassette with no safety tab inserted. <i>See page 25.</i>
Tape plays over and over	<ul style="list-style-type: none"> • Auto repeat turned on. <i>See page 19.</i>
Tape starts playing automatically	<ul style="list-style-type: none"> • Auto play feature turned on. <i>See page 19.</i>
TV/VCR turns off automatically	<ul style="list-style-type: none"> • Sleep timer turned on. Press TV or VCR to turn TV/VCR back on.
TV/VCR turns on automatically	<ul style="list-style-type: none"> • Wake up timer (alarm) turned on. <i>See page 10.</i>
Cannot record one program while watching a different program	<ul style="list-style-type: none"> • TV/VCR only has one tuner. Only one program can be watched and recorded at the same time.
Parental Controls are not blocking programs	<ul style="list-style-type: none"> • Make sure Parental Control is turned on. <i>See pages 11-15.</i>
Parental Control password does not work	<ul style="list-style-type: none"> • Reset Parental Control password. <i>See page 15.</i>
Front Panel Buttons won't work	<ul style="list-style-type: none"> • Front Panel Block is on. <i>See page 10.</i>

Cleaning the TV/VCR

Turn off the TV/VCR before cleaning.

You can clean the TV/VCR as required by using a soft cloth or the dusting attachment of your vacuum cleaner. Be sure to occasionally vacuum the ventilation slots in the cabinet to help assure adequate ventilation.

To clean the TV/VCR screen, use a soft cloth dampened with a diluted soap and water mixture. Do not use furniture polish on the TV/VCR cabinet or screen.

While cleaning, do not spray liquid directly on the screen or allow liquid to run down the screen or inside the TV/VCR. Also, avoid placing drinks or vases with water on top of the TV/VCR. This could increase the risk of fire, shock hazard, or damage to the TV/VCR.

Limited Warranty

What your warranty covers:

- Any defect in material or workmanship.

For how long after your purchase:

- Ninety days for labor charges.
- One year for parts.
- Two years for picture tube.

(The warranty period for rental units begins with the first rental or 45 days from date of shipment to the rental firm, whichever comes first.)

What we will do:

- Pay any Authorized RCA VCR Service Center the labor charges to repair your TV/VCR.
- Pay any Authorized RCA VCR Service Center for the new or, at our option, rebuilt replacement parts and picture tube required to repair your TV/VCR.

How you get service:

- For screen sizes of 26" and smaller:
Take your RCA TV/VCR to any Authorized RCA VCR Service Center and pickup when repairs are complete.
- For screen sizes larger than 26":
Request home service from any Authorized RCA VCR Service Center, provided that your TV/VCR is located within the geographic territory covered by an Authorized RCA VCR Service Center. If not, you must take your TV/VCR to the Service Center location at your own expense, or pay for the cost the Service Center may charge to transport your TV/VCR to and from your home.
- To identify your nearest Authorized RCA VCR Service Center, ask your Dealer, look in the Yellow Pages, or call 1-800-336-1900.
- Show the Authorized Service Center Representative your sales receipt or other evidence of purchase date.

What your warranty does not cover:

- Customer instruction. (Your Owner's Manual clearly describes how to install, adjust, and operate your TV/VCR. Any additional information should be obtained from your Dealer.)
- Installation and related adjustments.
- Signal reception problems not caused by your TV/VCR.
- Damage from misuse or neglect.
- Cleaning of video/audio heads.
- Batteries.
- A TV/VCR that has been modified or incorporated into other products or is used for institutional or other commercial purposes.
- Images burnt onto the screen.
- Acts of God, such as but not limited to lightning damage.
- A TV/VCR purchased or serviced outside the USA.

Product Registration:

- Please complete and mail the Product Registration Card packed in with your set. It will make it easier to contact you should it ever be necessary. The return of the card is not required for warranty coverage.

How state law relates to this warranty:

- This warranty gives you specific legal rights, and you also may have other rights that vary from state to state.

If you purchased your TV/VCR outside the United States:

- This warranty does not apply. Contact your dealer for warranty information.

Index

- ADD/REMOVE CHANNELS Menu 4
- Adding Channels to Memory 4
- Adjusting the Picture 8
- Adjusting Volume 5
- Age-based Ratings
 - Block 12
 - Defined 11
 - View 13
- Antenna System, Connecting 30
- AUDIO/VIDEO IN Jacks 23,24,25,27,28,29,32
- AUTO CHANNEL SEARCH Menu 4
- Auto Play Feature 19
- Auto Repeat Feature 19
- Automatic Head Cleaner 22
- Automatic Tracking 18
- Back Panel Controls 29
- Basic Recording 23
- Batteries, Installing in Remote 2
- Blank Search Feature 21
- BLANK SEARCH Screen 21
- Block
 - Age-based Ratings 12
 - Content Themes 13
 - Unrated Programs 15
- Brite (Brightness) Function 8
- Buttons, Remote Control 6,7
- Cable System without Cable Box, Connecting .. 30
- Cable System with Cable Box, Connecting 31
- Camcorder, Connecting to TV/VCR 32
- Captions, Closed 9
- Cautions i
- CHAN Buttons 5,6
- Channel Memory, Programming 4
- Channel, Selecting 5
- Chart, Recording Speeds 22
- Checking a Timer Recording 26
- Checking for Trouble 33,34
- Choisissez une Langue 3
- Choosing a Hookup 29
- Cleaning the TV/VCR 35
- CLEAR Button 5,6,10,18,26
- Clearing a Timer Recording 26
- Clock Setting (Setting Time and Date) 5
- CLOSED CAPTIONING Menu 9
- Closed Captions 9
- Color Function 8
- Commercial Scan 18
- Commercial Skip 9
- Connections
 - Antenna 30
 - Cable System With Cable Box for
 - All Channels 31
 - Cable System With Cable Box for
 - Premium Channels 31
 - Cable System With No Cable Box 30
 - Camcorder to Copy Tapes 32
 - Choosing a Hookup 29
 - Dipole Antenna 30
 - VCR to Copy Tapes 32
- Content Themes
 - Block 13
 - Defined 11
 - View 14
- Contents 1
- Contr (Contrast) Function 8
- Controls, Back Panel 29
- Controls, Front Panel 28
- Controls, Remote 6,7
- Copying Tapes 27,32
- Daily Programs, Recording 25
- Date, Setting 5
- Dipole Antenna, Connecting 30
- DISPLAY Button 6,8,18,21
- Displays, On-Screen 8
- Editing Tapes 27
- Electronic Program Indexing 20
- English Language 3
- Escoje un Idioma 3
- Express Recording 24
- Factory Settings, Reset 8
- Features, Playback 17-21
- Features, Recording 22
- Features, TV/VCR 8-10
- F.ADV (Frame Advance) Button 6,17
- FF (Fast Forward) Button 6,17,20,21,27,28
- First-Time Operation 2-5
- French Language 3
- Frame Advance 6,17
- Front Panel Block 10
- Front Panel Controls 28
- Home Antenna System, Connecting 30
- Hookups
 - Antenna 30
 - Cable System With Cable Box for
 - All Channels 31
 - Cable System With Cable Box for
 - Premium Channels 31
 - Cable System With No Cable Box 30
 - Camcorder to Copy Tapes 32
 - Dipole Antenna 30
 - VCR to Copy Tapes 32
- Important Information i
- Index Feature 20
- Information, Important i
- Language for Displays 3
- LANGUAGE/IDIOMA/LANGUE Menu 3
- Light Button 6
- Limited Warranty 36
- Location of Controls 28,29
- Lock Parental Controls 15
- LP Speed 22
- Manual Tracking 18
- MENU Button 3-6,8-10,19,25
- Movie Rating Limits
 - Block 14
 - View 15
- MUTE Button 6
- Note to Cable TV Installer i

Index

- Number Buttons7
- On-Screen Displays8
- Operation
 - Express Record24
 - Picture, Adjust8
 - Play a Tape16
 - Program Channel Memory4
 - Record a Program23
 - Set the Sleep Timer10
 - Set the Time and Date (Clock)5
 - Set the Wake-up Timer10
 - Timer Record25
- Parental Controls11-15
- PAUSE Button7,17,22,27
- Pause During Playback17
- Pause During Recording22
- Picture, Adjusting8
- PICTURE QUALITY Menu8
- Picture, Reset to Factory Settings8
- Picture Search17
- Picture Settings8
- PLAY Button7,28
- Playback
 - Auto Play19
 - Blank Search21
 - Commercial Scan18
 - Features17-21
 - Index20
 - Pause17
 - Play a Tape16
 - Repeat19
 - Zero21
- POWER Button and Indicator28
- PREV (Previous Channel) Button7
- Problem Solving33,34
- Programming Channel Memory4
- Rating Limits
 - TV12-14
 - Movie14-15
- REC (Record) Button and Indicator7,23,24,27
- Recording
 - Basic23
 - Express24
 - Features22
 - Pause22
 - Speeds and Chart22
 - Timer25
- Remote Batteries, Installing2
- Remote Control Buttons6,7
- Remote Sensor26
- Removing Channels from Memory4
- RESET Button7,10
- Resetting Picture to Factory Settings8
- REW (Rewind) Button7,28
- Safety Tab16,23,24,25
- Scan and Play Index Feature20
- Scan, Commercial18
- SEARCH
 - Blank21
 - Index20
 - Picture17
 - Zero21
- Selecting a Channel5
- Selecting a Language for Displays3
- Sensor, Remote28
- Setting
 - a Timer Recording25
 - an Express Recording24
 - Rating Limits11-15
 - the Clock5
 - the Date5
 - the Time5
 - Up the TV/VCR2-5
- Sharp (Sharpness) Function8
- Signal type4
- SKIP/SEARCH Button7,9,18,20,21
- SLEEP Button7
- Sleep Timer10
- SLP Speed22
- Solving Problems33,34
- SP Speed22
- Spanish Language3
- SPEED (Tape Speed) Button7
- Speeds, Recording22
- STOP Button7,28
- STOP/EJECT Button16,23,24,28
- Stopping a Timer Recording26
- Stopping Express Recording24
- Tab, Safety16,23,24,25
- Table of Contents1
- Tape, How to Play16
- Tapes, Copying27
- Tapes, Editing27
- Text Mode, Closed Captioning9
- Time Counter18,22
- TIME Menu5,10
- Time, Setting5
- TIMER REC Indicator24,25,28
- Timer Recording
 - Checking26
 - Clearing26
 - Setting25
 - Stopping26
- Tint Function8
- TRACKING Buttons7,16
- Tracking, Automatic18
- Tracking, Manual18
- Trouble Checks33,34
- Turn on TV/VCR3
- TV Rating Limits
 - Block12
 - Setting12
 - View13

Index

TV/VCR MAIN MENU	3,4,5,9,10,19,22,23,25,26
TV/VCR Setup	2-5
Types of Recordings	22
Unlock Parental Controls	15
Unrated Programs, Block/View	15
V-Chip	
Defined	11
Movie Ratings	14-15
TV Ratings	12-14
Unrated Programs	15
VCR, Connecting to TV/VCR	32
VIDEO/AUDIO IN Jacks	24,25,27,28,29,30
VOL (Volume) Buttons	7,26
Volume, Adjusting	5
WAKE-UP Indicator	10,28
WAKE-UP Timer	10
Warnings	i
Warranty, Limited	36
Weekdays (M-F), Recording	25
Weekly Program, Recording	25
ZERO SEARCH Screen	21

For your nearest Authorized Servicenter
call toll-free in the USA.

1-800-336-1900

Canadian Consumers —
Your toll-free numbers are:

English: 1-800-522-0338

French: 1-800-522-0445

If your product needs service, please contact your dealer or
the nearest servicenter from the Yellow Pages. Please do not
send any products to the Indianapolis address listed in this
manual or on the carton. This will only add delays in service
for your product.

 **THOMSON CONSUMER ELECTRONICS**

**10330 N Meridian Street
Indianapolis, IN 46290**

©1999 Thomson Consumer Electronics, Inc.

Trademark(s)® Registered

Marca(s) Registrada(s)

Printed in Thailand.

15392100